

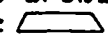



Werkstatt - Kennzeichen für instandgesetzte, überprüfte, überholte und geänderte Erzeugnisse

1. Kennzeichen für instandgesetzte Erzeugnisse und Teile

Alle von unseren Kundendienststellen und Instandsetzungsbetrieben (iA4, HoW oder HiW) instandgesetzten Erzeugnisse und Teile werden dort mit einem Kennzeichen versehen, aus dem ersichtlich ist, wer die Instandsetzung durchgeführt hat.







Als Kennzeichen werden 1, 2 oder 3 Großbuchstaben mit Schlagstempel eingeschlagen, die entweder von einem Trapez  oder einem gleichseitigen Dreieck  eingerahmt sind, bzw. hinter einem Winkel  oder auf einem umgekehrten "T"  stehen.

Das Instandsetzungskennzeichen wird möglichst in der Nähe der anderen Aufschrift angebracht, jedoch nicht auf dem Typenschild und auch nicht so, daß es als Bestandteil der Bestellnummer oder der Typformel angesehen werden kann.

Die Datumskennzahl muß zusätzlich neben oder unter dem Instandsetzungskennzeichen angebracht werden.

Für instandgesetzte Erzeugnisse oder Teile gelten die Gewährleistungsbestimmungen für Einbau- und Instandsetzungsarbeiten.

Beispiele
Kennzeichen bedeutet instandgesetzt von





	061	VH Hannover	im Januar 1990
	172	BD Reutlingen	im Dezember 1991
	063	BD Alzey	im März 1990
	165	BD EISENBERG	im Mai 1991
	067	BD Bünde	im Juli 1990
	167	BG Sauret, Clermont-Ferrand/ Frankreich	im Juli 1991
	071	BD Walch, Bludenz/Österreich	im November 1990
	261	RG RBCA, Toronto/Kanada	im Januar 1992
	171	Produktbereich iA4 - Plochingen	im November 1991
	072	HoW	im Dezember 1990
	170	Instandsetzung bei KH/VSK	im Oktober 1991

Erläuterungen: VH = Verkaufshaus
RG = Bosch Regional-Gesellschaft
BD = Bosch-Dienst

2. Kennzeichen für überprüfte, überholte oder geänderte Erzeugnisse vom Zentral-lager Bosch oder Fabrikkunden.

Erzeugnisse, die mit ein oder zwei Buchstaben in einem eckigen, offenen  gekennzeichnet sind, wurden von Werkstätten der Verkaufshäuser, Produktbereich iA4 - Plochingen oder RG überprüft oder geändert. Der Zeitpunkt ist aus der daneben eingeschlagenen Datumskennzahl ersichtlich. Für diese Erzeugnisse gelten die gleichen Gewährleistungsbestimmungen wie für neue Erzeugnisse.

Beispiele
Kennzeichen bedeutet überholt oder geändert von

	169	VH München	im September 1991
	262	iA4-Plochingen	im Februar 1992
	168	UA-at	im August 1991
	161	RBCA	im Januar 1991







3. Kennzeichen für Austausch-Instandsetzungen

Bei iA4, HiW oder Zweigbetrieb des Werkes instandgesetzte Austausch-Erzeugnisse werden mit Buchstaben in einem offenen runden  gekennzeichnet. Unter oder neben diesem Zeichen ist die Datumskennzahl der Austausch-Instandsetzung eingeschlagen.

Für diese Erzeugnisse gelten die im Garantiehandbuch angegebenen Gewährleistungsbestimmungen.





Beispiele

Kennzeichen bedeutet im Austausch instandgesetzt

	164	HiW	im April 1991
	172	LW	im Dezember 1991
	065	HoW	im Mai 1990
	067	NüW	im Juli 1990
	066	iA4-Plochingen	im Juni 1990
	172	BhW	im Dezember 1991
	068	RBSP	im August 1990

Auf den von iA4, HiW oder HoW instandgesetzten Austausch-Erzeugnissen ist außer der Stempelung von Buchstaben im offenen, runden U noch ein gelb/roter Aufkleber "Austausch Bosch" deutlich sichtbar angebracht.

Erzeugnisse, die von einer KD-Stelle im Austausch instandgesetzt werden, sind mit dem für sie festgelegten Zeichen und der Datumskennzahl zu stempeln.

	167	HiW-Gö	im Juli 1991
	163	RBGB	im März 1991
	069	RBTR	im September 1990
	162	UA	im Februar 1991

4. Datumskennzahlen

Laufendes Jahr	1990	1991	1992	1993	1994	1995	1996	1997	1998	1999
Monatskennzahl										
Januar	061	161	261	361	461	561	661	761	861	961
Februar	062	162	262	362	462	562	662	762	862	962
März	063	163	263	363	463	563	663	763	863	963
April	064	164	264	364	464	564	664	764	864	964
Mai	065	165	265	365	465	565	665	765	865	965
Juni	066	166	266	366	466	566	666	766	866	966
Juli	067	167	267	367	467	567	667	767	867	967
August	068	168	268	368	468	568	668	768	868	968
September	069	169	269	369	469	569	669	769	869	969
Oktober	070	170	270	370	470	570	670	770	870	970
November	071	171	271	371	471	571	671	771	871	971
Dezember	072	172	272	372	472	572	672	772	872	972

5. Maße zur Anfertigung der Kennzeichen-Schlagstempel

KERBE 0,5 MM TIEF

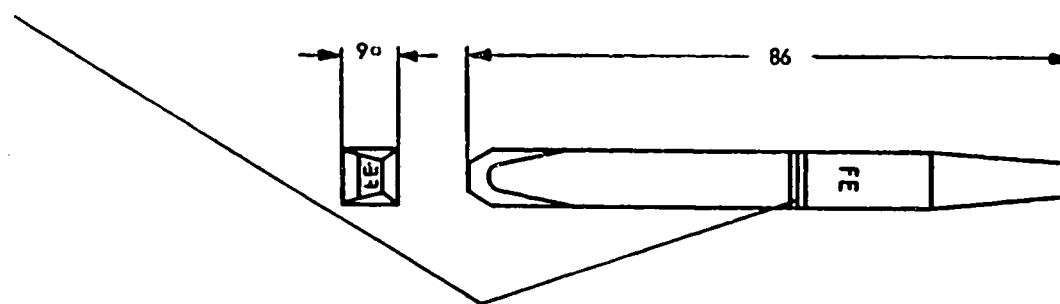



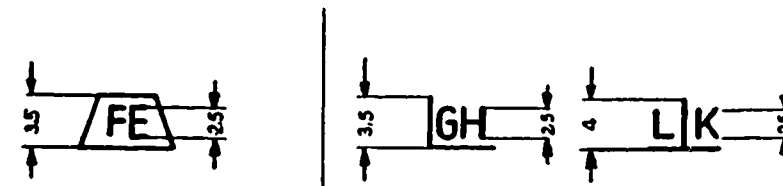

Beispiele für eingeschlagene Kennzeichen Maßstab 2 : 1



WORKSHOP DESIGNATIONS FOR REPAIRED,
CHECKED, SUPERSEDED AND MODIFIED PRODUCTS.

1. DESIGNATIONS FOR REPAIRED PRODUCTS AND PARTS

ALL PRODUCTS AND PARTS REPAIRED BY OUR CUSTOMER SERVICE CENTRES AND OUR REPAIR WORKSHOPS (iA4, HoW OR HiW) ARE GIVEN AN IDENTIFICATION NUMBER IN THE CUSTOMER SERVICE CARRIED OUT THE REPAIR.

THE DESIGNATION WILL BE IN THE FORM OF 1, 2, OR 3 CAPITAL LETTERS STAMPED IN WITH A MARKING PUNCH AND SURROUNDED BY EITHER A TRAPEZIUM  OR AN EQUILATERAL TRIANGLE , OR PLACED BEHIND A RIGHT ANGLE  OR ON AN INVERTED "T" .











WHERE POSSIBLE, THE REPAIR IDENTIFICATION NUMBER WILL BE PLACED NEAR TO THE OTHER DESIGNATIONS, BUT NOT ON THE NAMEPLATE, NOR IN SUCH A MANNER THAT IT COULD BE UNDERSTOOD AS BEING PART OF THE PART NUMBER OR THE TYPE DESIGNATION.

THE DATE CODE MUST ADDITIONALLY BE POSITIONED NEXT TO OR BELOW THE REPAIR IDENTIFICATION NUMBER.

FOR REPAIRED PRODUCTS OR PARTS THE WARRANTY CONDITIONS FOR INSTALLATION AND REPAIR WORKS APPLY.

EXAMPLES

DESIGNATION DENOTES REPAIRS CARRIED OUT BY

	061	VH HANNOVER	IN JANUARY 1990
	172	BD REUTLINGEN	IN DECEMBER 1991
	063	BD ALZEY	IN MARCH 1990
	165	BD EISENBERG	IN MAY 1991
	067	BD BUENDE	IN JULY 1990
	167	BG SAURET, CLERMONT-FERRAND/ FRANKREICH	IN JULY 1991
	071	BD WALCH, BLUDENZ/ÖSTERREICH	IN NOVEMBER 1990
	261	RG RBCA, TORONTO/KANADA	IN JANUARY 1992
	171	PRODUCT SECTOR iA4 - PLOCHINGEN WORKS-SHOPS PLB	IN NOVEMBER 91
	072	HoW	IN DECEMBER 1990
	170	REPAIRS BY KH/VSK	IN OCTOBER 1991

KEY TO ABBREVIATIONS: VH = SALES CENTER
RG = BOSCH REGIONAL SUBSIDIARY
BD = BOSCH AFTER-SALES SERVICE





2. DESIGNATIONS FOR CHECKED, SUPERSEDED OR MODIFIED PRODUCTS FROM CENTRAL BOSCH STORES OR FACTORY CUSTOMERS.

PRODUCTS WHICH ARE IDENTIFIED WITH ONE OR TWO LETTERS INSIDE A RECTANGULAR, OPEN  HAVE BEEN CHECKED OR AMENDED BY WORKSHOPS OF THE RETAIL OUTLETS, PRODUCT SECTOR iA4 - PLOCHINGEN OR RG. THE DATE OF CHECKING IS GIVEN ON THE PUNCHED STAMP ALONGSIDE.

THE SAME GUARANTEE REGULATIONS APPLY TO THESE PRODUCTS AS FOR NEW PRODUCTS.

EXAMPLES

DESIGNATION DENOTES CHECKED OR MODIFIED BY

	169	VH MÜNCHEN	IN SEPTEMBER 1991
	262	iA4 PLOCHINGEN	IN FEBRUARY 1992
	168	UA-at	IN AUGUST 1991
	161	RBCA	IN JANUARY 1991

3. DESIGNATIONS FOR EXCHANGE REPAIRS

EXCHANGE PRODUCTS REPAIRED AT iA4, HiW OR IN A BRANCH OF THE WORKS ARE IDENTIFIED WITH LETTERS IN AN OPEN, ROUNDED \cup .

BELOW OR NEXT TO THIS DESIGNATION THE DATE OF THE EXCHANGE REPAIRS IS STAMPED IN.

THE GUARANTEE CONDITIONS GIVEN IN THE WARRANTY MANUAL APPLY TO THESE PRODUCTS.

EXAMPLES

DESIGNATIONS MEAN REPAIRED IN EXCHANGE BY

\cup E	164	HiW	IN APRIL 1991
\cup L	172	LW	IN DECEMBER 1991
\cup R	065	HoW	IN MAY 1990
\cup T	067	NuW	IN JULY 1990
\cup Y	066	iA4-PLOCHINGEN	IN JUNE 1990
\cup Z	172	BHW	IN DECEMBER 1991
\cup EC	068	RBSP	IN AUGUST 1990

ON THE EXCHANGE PRODUCTS REPAIRED BY iA4, HiW OR HoW, AS WELL AS THE STAMPING OF LETTERS IN THE OPEN, ROUNDED \cup , A FURTHER YELLOW/RED ADHESIVE STICKER, \cup "BOSCH EXCHANGE", IS TO BE ATTACHED IN A CLEARLY VISIBLE POSITION.

PRODUCTS WHICH HAVE BEEN REPAIRED BY A CUSTOMER SERVICE POINT IN THE COURSE OF AN EXCHANGE ARE TO BE STAMPED WITH THE IDENTIFICATION SET DOWN FOR THEM AND WITH THE DATE CODE.

\cup EG	167	HiW-Gö	IN JULY 1991
\cup GB	163	RBGB	IN MARCH 1991
\cup TR	069	RBTR	IN SEPTEMBER 1990
\cup UH	162	UA	IN FEBRUARY 1991

4. DATE FIGURES

RUNNING YEAR	1990	1991	1992	1993	1994	1995	1996	1997	1998	1999
MONTH FIGURE										
JANUARY	061	161	261	361	461	561	661	761	861	961
FEBRUARY	062	162	262	362	462	562	662	762	862	962
MARCH	063	163	263	363	463	563	663	763	863	963
APRIL	064	164	264	364	464	564	664	764	864	964
MAY	065	165	265	365	465	565	665	765	865	965
JUNE	066	166	266	366	466	566	666	766	866	966
JULY	067	167	267	367	467	567	667	767	867	967
AUGUST	068	168	268	368	468	568	668	768	858	968
SEPTEMBER	069	169	269	369	469	569	669	769	869	969
OCTOBER	070	170	270	370	470	570	670	770	870	970
NOVEMBER	071	171	271	371	471	571	671	771	871	971
DECEMBER	072	172	272	372	472	572	672	772	872	972

5. DIMENSIONS FOR MANUFACTURING THE DESIGNATION STAMP

NOTCH 0,5 MM DEEP

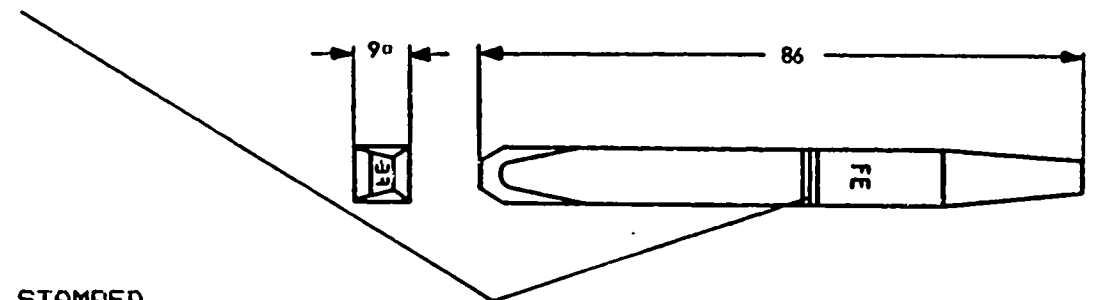

EXAMPLES OF STAMPED DESIGNATIONS SCALE 2:1

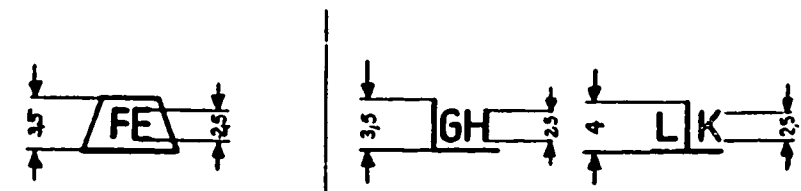

MARQUAGES D'IDENTIFICATION DES ATELIERS SUR LES PRODUITS REMIS EN ETAT, CONTROLES, REVISES ET MODIFIES.

1. MARQUAGES D'IDENTIFICATION DES PRODUITS ET DES PIECES REMIS EN ETAT.

TOUS LES PRODUITS ET PIECES REMIS EN ETAT PAR TOUS NOS POINTS S.A.V. ET NOS CENTRES DE REMISE EN ETAT (iA4, HoW OU HiW) DOIVENT Y ETRE POURVUS D'UN CODE PERMETTANT D'IDENTIFIER L'AUTEUR DE LA REMISE EN ETAT.

COMME MARQUES, ON UTILISE 1, 2 OU 3 LETTRES CAPITALES MARQUEES AU POINCON QUI SONT ENCADREES SOIT DANS UN TRAPEZE  SOIT DANS UN TRIANGLE  EQUILATERAL OU ALORS ELLES SONT PLACEES DERRIERE UN ANGLE  DROIT OU SUR UN "T" RENVERSE .









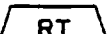

LE CODE DE REPARATION EST PLACEE LE PLUS PRES POSSIBLE DE LA PLAQUE SIGNALETIQUE; CEPENDANT, ELLES NE SONT PAS GRAVEES SUR LA PLAQUE SIGNALETIQUE ET AUSSI D'UNE MANIERE PRETANT A CONFUSION POUR QU'ON NE PUISSE PAS CROIRE QU'ELLES FONT PARTIE DE LA REFERENCE OU DE LA FORMULE DE TYPE.

LE CODE DE DATE DOIT EN OUTRE ETRE INDIQUE A COTE OU SOUS LE CODE DE REPARATION.

LES CONDITIONS DE GARANTIE POUR LES TRAVAUX DE MONTAGE ET DE REMISE EN ETAT SONT APPLICABLES AUX PRODUITS OU PIECES REMIS EN ETAT.

EXEMPLES:

LES MARQUES SUIVANTES SIGNIFIENT QUE LES PRODUITS ONT ETE REMIS EN ETAT PAR LES ATELIERS SUIVANTS:

 HR	061	VH HANOURE	EN JANVIER 1990
 RT	172	BD REUTLINGEN	EN DECEMBRE 1991
 AY	063	BD ALZEY	EN MARS 1990
 EA	165	BD EISENBERG	EN MAI 1991
 B E	067	BD BUENDE	EN JUILLET 1990
 217	167	BG SAURET, CLERMONT-FERRAND/FRANKREICH	EN JUILLET 1991
 D BW	071	BD WALCH, BLUDENZ/ÖSTERREICH	EN NOVEMBRE 1990
 CTA	261	RG RBCA, TORONTO/KANADA	EN JANVIER 1992
 Y	171	SECTEUR PRODUIT iA4 - PLOCHINGEN	EN NOVEMBRE 1991
 R	072	HoW	EN DECEMBRE 1990
 KH	170	REMISE EN ETAT CHEZ KH/VSK	EN OCTOBRE 1991

EXPLICATIONS: VH = BUREAU DE VENTE BOSCH
RG = BOSCH SOCIETE REGIONALE
BD = SERVICE BOSCH





2. MARQUAGES D'IDENTIFICATION DES PRODUITS CONTROLES, REVISES OU MODIFIES PAR LE MAGASIN CENTRAL BOSCH OU PAR LES CLIENTS DES USINES.

LES PRODUITS IDENTIFIES PAR UNE OU DEUX LETTRES DANS UN ENPLACEMENT EN FORME DE CARRE OUVERT  ONT ETE VERIFIES OU MODIFIES PAR LES ATELIERS DES MAISONS DE VENTE, LE SECTEUR PRODUIT iA4 OU LES RG. LA DATE DE CONTROLE OU DE MODIFICATION PEUT ETRE DECHIFFREE SUR LE CODE DE LA DATE POINCONNE A COTE.

POUR CES PRODUITS, LES CONDITIONS DE GARANTIE SONT LES MEME QUE CELLES POUR LES PRODUITS NEUFS.

EXEMPLE

LA MARQUE D'IDENTIFICATION SIGNIFIE REVISE OU MODIFIE PAR

 MU	169	VH MUNICH	EN SEPTEMBRE 1991
 Y	262	iA4-PLOCHINGEN	EN FEVRIER 1992
 UA	168	UA-at	EN AOUT 1991
 CT	161	RBCA	EN JANVIER 1991

3. MARQUAGES D'IDENTIFICATION POUR LES REMISES EN ETAT DES APPAREILS D'ECHANGE







STANDARD.

LES PRODUITS D'ECHANGE STANDARD REMIS EN ETAT PAR IA4, HiW OU UNE SUCCURSALE DE L'USINE SONT IDENTIFIES PAR DES LETTRES INDIQUEES DANS UN EMBLEMME OUVERT DE FORME ARRONDIE . LA DATE CORRESPONDANTE DU PRODUIT D'ECHANGE STANDARD REMIS EN ETAT EST MARQUEE AU POINCON EN DESSOUS OU A COTE DE CE CODE.

POUR CES PRODUITS, LES CONDITIONS DE GARANTIE VALABLES SONT CELLES INDIQUEES DANS LE MANUEL DE GARANTIE.





EXEMPLES

LA MARQUE D'IDENTIFICATION SIGNIFIE REMIS EN ETAT DANS LE CADRE DES ECHANGES STANDARD PAR:

 164	HiW	EN AVRIL 1991
 172	LW	EN DECEMBRE 1991
 065	HoW	EN MAI 1990
 067	NUW	EN JUILLET 1990
 066	IA4-PLOCHINGEN	EN JUNI 1990
 172	BhW	EN DECEMBRE 1991
 068	RBSP	EN AOUT 1990

SUR LES PRODUITS D'ECHANGE STANDARD REMIS EN ETAT PAR IA4, HiW OU HoW FIGURE DE FACON BIEN VISIBLE UN AUTOCOLLANT JAUNE/ROUGE "ECHANGE STANDARD BOSCH",  EN PLUS DES LETTRES INDIQUEES DANS L'EMPLACEMENT OUVERT DE FORME ARRONDIE.

LES PRODUITS REMIS EN ETAT PAR UN POINT S.A.V. DANS LE CADRE DE L'ECHANGE STANDARD DOIVENT ETRE TAMPONNES DE LEUR CODE SPECIFIQUE ET DU CODE DE DATE.

 167	HiW-Gö	EN JUILLET 1991
 163	RBGB	EN MARS 1991
 069	RBTR	EN SEPTEMBRE 1990
 162	UA	EN FEVRIER 1991

4. CODE DES DATES

ANNEES SUCCES.	1990	1991	1992	1993	1994	1995	1996	1997	1998	1999
CODE DU MOIS										
JANVIER	061	161	261	361	461	561	661	761	861	961
FEVRIER	062	162	262	362	462	562	662	762	862	962
MARS	063	163	263	363	463	563	663	763	863	963
AVRIL	064	164	264	364	464	564	664	764	864	964
MAI	065	165	265	365	465	565	665	765	865	965
JUIN	066	166	266	366	466	566	666	766	866	966
JUILLET	067	167	267	367	467	567	667	767	867	967
AOUT	068	168	268	368	468	568	668	768	868	968
SEPTEMBRE	069	169	269	369	469	569	669	769	869	969
OCTOBRE	070	170	270	370	470	570	670	770	870	970
NOVEMBRE	071	171	271	371	471	571	671	771	871	971
DECEMBRE	072	172	272	372	472	572	672	772	872	972

5. COTES A RESPECTER POUR LA CONFECTION D'UN POINCON A FRAPPER LA MARQUE D'IDENTIFICATION

ENCOCHE DE 0,5 MM DE PROFONDEUR

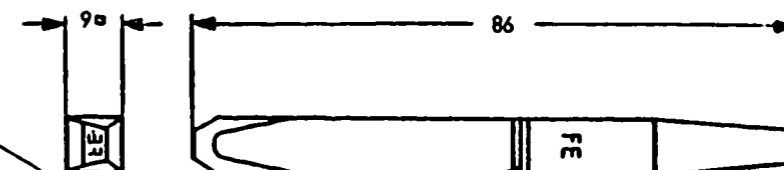



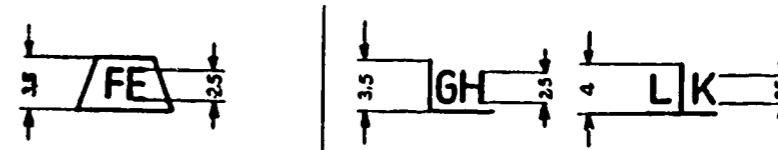

EXEMPLES DE MARQUAGES AU POINCON DES CODES D'IDENTIFICATION
ECHELLE 2:1



SIMBOLOS DE TALLER PARA PRODUCTOS REPARADOS, VERIFICADOS, REPASADOS Y MODIFICADOS.

1. SIMBOLOS PARA PRODUCTOS Y PIEZAS REPARADOS.

TODOS LOS PRODUCTOS Y LAS PIEZAS REPARADOS POR NUESTROS PUNTOS DE SERVICIO POSTVENTA Y NUESTROS TALLERES DE REPARACIONES (iA4, HoW O HiW) SON PROVISTOS ALLI DE UN CODIGO QUE PERMITE DETERMINAR QUIEN HA REALIZADO LA REPARACION.

COMO SIMBOLO SE GRABAN CON UN FUNZON 1, 2 O 3 LETRAS MAYUSCULAS QUE SE ENCUENTRAN DENTRO DE UN TRAPEZIO  O DE UN TRIANGULO  EQUILATERAL O DETRAS DE UN ANGULO  O SOBRE UN "T" INVERTIDO. .











EL CODIGO DE REPARACION SE APLICA, DE SER POSIBLE, EN LA PROXIMIDAD DEL ROTULO YA EXISTENTE, PERO NO EN LA PLACA CARACTERISTICA NI TAMPOCO DE FORMA QUE PUEDA SER CONSIDERADO COMO PARTE DEL NUMERO DE PEDIDO O DE LA DESIGNACION DE TIPO.

EL CODIGO DE LA FECHA TIENE QUE APLICARSE ADICIONALMENTE AL LADO O POR DEBAJO DEL CODIGO DE REPARACION.

PARA PRODUCTOS O PIEZAS REPARADOS SE APLICAN LAS CONDICIONES DE GARANTIA CORRESPONDIENTES A TRABAJOS DE MONTAJE Y REPARACION.

EJEMPLOS

EL SIMBOLO SIGNIFICA REPARADO POR:

	061	VH HANNOVER	ENERO 1990
	172	BD REUTLINGEN	DICIEMBRE 1991
	063	BD ALZEY	MARZO 1990
	165	BD EISENBERG	MAYO 1991
	067	BD BUENDE	JULIO 1990
	167	BG SAURET, CLERMONT-FERRAND/FRANKREICH	JULIO 1991
	071	BD WALCH, BLUDENZ/ÖSTERREICH	NOVIEMBRE 1990
	261	RG RBCA, TORONTO/KANADA	ENERO 1992
	171	AREA DE PRODUCTOS iA4-PLOCHINGEN	NOVIEMBRE 1991
	072	HoW	DICIEMBRE 1990
	170	REPARACION POR KH/VSK	OCTUBRE 1991

EXPLICACIONES: VH = VERKAUFSHAUS (CASA DE VENTA)
 RG = BOSCH SOCIEDAD REGIONAL
 BD = BOSCH-DIENST (SERVICIO BOSCH)

2. SIMBOLOS PARA PRODUCTOS VERIFICADOS, REPASADOS O MODIFICADOS POR EL ALMACEN CENTRAL O EL CLIENTE DE FABRICA.





LOS PRODUCTOS IDENTIFICADOS CON UNA O DOS LETRAS DENTRO DE UN ENMARCADO ANGULAR ABIERTO  HAN SIDO VERIFICADOS O MODIFICADOS POR TALLERES DE LAS CASAS VENEDORAS, POR EL AREA DE PRODUCTOS iA4-PLOCHINGEN OR POR RG.

LA FECHA PUEDE DESPRENDERSE DE LA CIFRA GRABADA AL LADO.

PARA ESTOS PRODUCTOS RIGEN LAS MISMAS PRESCRIPCIONES DE GARANTIA COMO PARA PRODUCTOS NUEVOS.

EJEMPLOS

EL SIMBOLO SIGNIFICA REPASADO O MODIFICADO POR







	169	VH MÜNCHEN	SEPTIEMBRE 1991
	262	iA4-PLOCHINGEN	FEBRERO 1992
	168	UA-at	AGOSTO 1991
	161	RBCA	ENERO 1991

3. SIMBOLOS PARA REPARACIONES DE PRODUCTOS REACONDICIONADOS

LOS PRODUCTOS DE CANJE REPARADOS EN iA4, HiW O EN UNA SUCURAL DE LA FABRICA SE IDENTIFICAN CON LETRAS DENTRO DE UN ARCO CONCAVO ABIERTO  DEBAJO O AL LADO DE ESTE SIMBOLO ESTA GRABADA LA CIFRA DE LA FECHA DE LA REPARACION DE CANJE. PARA ESTOS PRODUCTOS RIGEN LAS PRESCRIPCIONES DE GARANTIA INDICADAS EN EL MANUAL DE GARANTIA.





EJEMPLOS

EL SIMBOLO SIGNIFICA REACONDICIONADO POR

 164	HiW	EN ABRIL 1991
 172	LW	EN DICIEMBRE 1991
 065	HoW	EN MAYN 1990
 067	NüW	EN JULIO 1990
 066	iA4-PLOCHINGEN	EN JUNIO 1990
 172	BhW	EN DICIEMBRE 1991
 068	RBSP	EN AGOSTO 1990

EN LOS PRODUCTOS DE CANJE REPARADOS POR iA4, HiW O HoW, ADEMAS DE LAS LETRAS DENTRO DEL ARCO CONCAVO ABIERTO  SE APLICA EN UN LUGAR CLARAMENTE VISIBLE UNA ETIQUETA ADHESIVA AMARILLA/ROJA CON LA INSCRIPCION "CANJE BOSCH".

LOS PRODUCTOS REPARADOS POR UN PUNTO DE SERVICIO POSTVENTA DENTRO DEL PROCEDIMIENTO DE CANJE TIENEN QUE IDENTIFICARSE SELLANDOLOS CON EL CODIGO FIJADO PARA ELLOS Y CON EL CODIGO DE LA FECHA.

 167	HiW-Gö	EN JULIO 1991
 163	RBGB	EN MARZO 1991
 069	RBTR	EN SEPTIEMBRE 1990
 162	UA	EN FEBRERO 1991

4. CIFRAS DE FECHA

ANO CORRIENTE	1990	1991	1992	1993	1994	1995	1996	1997	1998	1999
CIFRA DEL MES										
ENERO	061	161	261	361	461	561	661	761	861	961
FEBRERO	062	162	262	362	462	562	662	762	862	962
MARZO	063	163	263	363	463	563	663	763	863	963
ABRIL	064	164	264	364	464	564	664	764	864	964
MAYO	065	165	265	365	465	565	665	765	865	965
JUNIO	066	166	266	366	466	566	666	766	866	966
JULIO	067	167	267	367	467	567	667	767	867	967
AGOSTO	068	168	268	368	468	568	668	768	868	968
SEPTIEMBRE	069	169	269	369	469	569	669	769	869	969
OCTUBRE	070	170	270	370	470	570	670	770	870	970
NOVIEMBRE	071	171	271	371	471	571	671	771	871	971
DICIEMBRE	072	172	272	372	472	572	672	772	872	972

5. COTAS PARA LA CONFECCION DE LOS PUNZONES DE MARCACION

RANURA, PROFUNDIDAD 0,5 MM

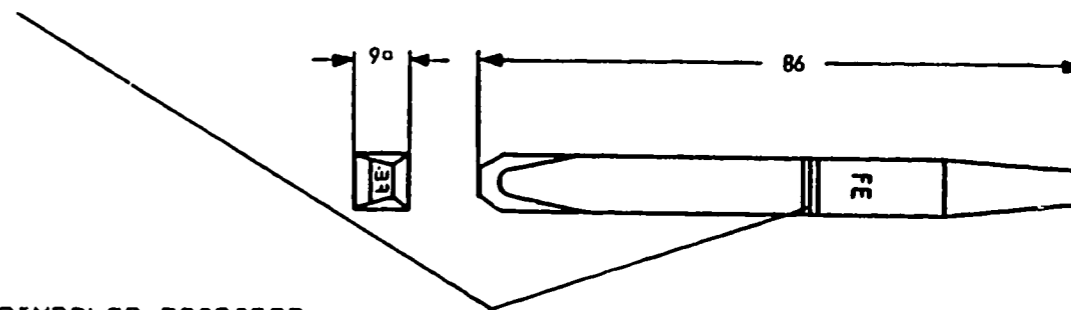

EJEMPLOS DE SIMBOLOS GRABADOS ESCALA 2:1

C

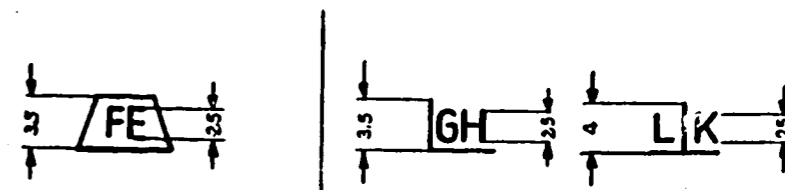

CONTRASSEGNI DI OFFICINA PER PRODOTTI RIPARATI, VERIFICATI, REVISIONATI E MODIFICATI.

1. CONTRASSEGNI PER PRODOTTI E COMPONENTI RIPARATI

TUTTI I PRODOTTI E I PEZZI PREPARATI DAI NOSTRI CENTRI DEL SERVIZIO ASSISTENZA E OFFICINE DI RIPARAZIONE (iA4, HoW O HiW) VENGONO MUNITI DI UN CONTRASSEGNO CHE INDICA CHI HA ESEGUITO LA RIPARAZIONE.

IL CONTRASSEGNO PUNZONATO E' COMPOSTO DA 1, 2, O 3 LETTERE MAIUSCOLE DENTRO UN TRAPEZIO , UN TRIANGOLO EQUILATERO  OPPURE DIETRO UNA "L"  O SU UNA "T" ROVESCIATA .











IL CONTRASSEGNO DI RIPARAZIONE IL PIU' VICINO POSSIBILE ALLA TARGHETTA, MA NON SU DI ESSA O IN MODO CHE IL CONTRASSEGNO POSSA VENIRE CONSIDERATO PARTE INTEGRANTE DEL NUMERO D'ORDINAZIONE O DELLA SIGLA.

ANCHE IL NUMERO D'IDENTIFICAZIONE DELLA DATA DEV'ESSERE RIPORTATO A FIANCO O SOTTO IL CONTRASSEGNO DI RIPARAZIONE.

PER I PRODOTTI O PEZZI PREPARATI VALGONO LE CLAUSOLE DI GARANZIA PER I LAVORI DI MONTAGGIO E DI RIPARAZIONE.

ESEMPI

IL CONTRASSEGNO SIGNIFICA CHE LA RIPARAZIONE E STATA ESEGUITA DA:

 HR	061	VH HANNOVER	IN GENNATO 1990
 RT	172	BD REUTLINGEN	IN DICEMBRE 1991
 AY	063	BD ALZEY	IN MARZO 1990
 EA	165	BD EISENBERG	IN MAGGIO 1991
 B E	067	BD BUENDE	IN LUGLIO 1990
 217	167	BG SAURET, CLERMONT-FERRAND/ FRANKREICH	IN LUGLIO 1991
 O BW	071	BV WALCH, BLUDENZ/ÖSTERREICH	IN NOVEMBRE 1990
 CTA	261	RG RBCA, TORONTO/KANADA	IN GENNAIO 1992
 Y	171	DIVISIONE PRODOTTI iA4-FLOCHINGEN	IN NOVEMBRE 1991
 R	072	HoW	IN DICEMBRE 1990
 KH	170	RIPARATO PRESSO LA SEDE CENTRALE	IN OTTOBRE 1991

ABBREVIAZIONI VH = UFFICIO DI VENDITA BOSCH
RG = BOSCH SOCIETA REGIONALE
BD = SERVIZIO BOSCH

2. CONTRASSEGNI PER PRODOTTI VERIFICATI,

REVISIONATI O MODIFICATI DAL MAGAZZINO





CENTRALE BOSCH O DALLE CASE COSTRUTTRICI

CLIENTI.

I PRODOTTI CONTRASEGNATI CON UNA O DUE LETTERE IN UN SIMBOLO  QUADRO APERTO, SONO STATI CONTROLLATI O MODIFICATI DALLE OFFICINE DELLE CASE DI VENDITA, DELLA DIVISIONE PRODOTTI iA4-PLOCHINGEN. LA DATA E RICONOSCIBILE DAL DODICE PUNZONATO A FIANCO DEL CONTRASSEGNO.

ESEMPI

IL CONTRASSEGNO SIGNIFICA CHE LA REVISIONE O LA MODIFICA SONO STATE ESEGUITE DA:

 MJ	169	VH MÜNCHEN	IN SETTEMBRE 1991
 Y	262	iA4-PLOCHINGEN	IN LIUGNO 1992
 UA	168	UA-at	IN AGOSTO 1991
 CT	161	RBCA	IN GENNAIO 1991

3. CONTRASSEGNI PER RIPARAZIONE DI PRODOTTI DI ROTAZIONE

I PRODOTTI REVISIONATI GARANTITI RIPARATI DA IA4, HiW O DA UNA FILIALE DELL'OFFICINA VENGONO CONTRASSEGNA TI CON DELLE LETTERE IN UN SIMBOLO TONDO APERTO. LA DATA DELLA RIPARAZIONE E' RIPO RTATA SOTTO O A FIANCO DEL CONTRASSEGNO . PER QUESTO PRODOTTI VALGONO LE STESSE CONDIZIONI DI GARANZIA ELENCA TE NEL LIBRETTO DI GARANZIA.

ESEMPI

IL CONTRASSEGNO SIGNIFICA IL PRODOTTO DI ROTAZIONE E STATO RIPARATO DALLO STABILIMENTO:

(E)	164	HiW	IN APRILE 1991
(L)	172	LW	IN DICEMBRE 1991
(R)	065	HoW	IN MAGGIO 1990
(T)	067	NuW	IN LUGLIO 1990
(Y)	066	IA4-PLOCHINGEN	IN LIUGNO 1990
(Z)	172	BhW	IN DICEMBRE 1991
(EC)	068	RBSF	IN AGOSTO 1990

SUI PRODOTTI REVISIONATI GARANTITI RIPARATI DA IA4, HiW O HoW VA APPLICATO IN MODO CHIARAMENTE VISIBILE, OLTRE ALLA STAMPIGLIATURA DELLE LETTERE IN UN SIMBOLO TONDO APERTO, ANCHE UN ADESIVO GIALLO/ROSSO "REVISIONATO GARANTITO BOSCH".

I PRODOTTI, CHE VENGONO RIPARATI NEL SERVIZIO "REVISIONATO GARANTITO" DA UN CENTRO DEL SERVIZIO ASSISTENZA, VANNO STAMPIGLIATI CON IL CONTRASSEGNO PER ESSI STABILITO E CON IL NUMERO D'IDENTIFICAZIONE DELLA DATA.

(EG)	167	HiW-Gö	IN LUGLIO 1991
(GB)	163	RBGB	IN MARZO 1991
(TR)	069	RBTR	IN SETTEMBRE 1990
(UH)	162	UA	IN LIUGNO 1991

4. CODICI DELLE DATE

ANNO IN CORSO	1990	1991	1992	1993	1994	1995	1996	1997	1998	1999
CODICE DEL MESE										
GENNAIO	061	161	261	361	461	561	661	761	861	961
FEBBRAIO	062	162	262	362	462	562	662	762	862	962
MARZO	063	163	263	363	463	563	663	763	863	963
APRILE	064	164	264	364	464	564	664	764	864	964
MAGGIO	065	165	265	365	465	565	665	765	865	965
GIUGNO	066	166	266	366	466	566	666	766	866	966
LUGLIO	067	167	267	367	467	567	667	767	867	967
AGOSTO	068	168	268	368	468	568	668	768	868	968
SETTEMBRE	069	169	269	369	469	569	669	769	869	969
OTTOBRE	070	170	270	370	470	570	670	770	870	970
NOVEMBRE	071	171	271	371	471	571	671	771	871	971
DICEMBRE	072	172	272	372	472	572	672	772	872	972

5. QUOTE DI FABBRICAZIONE DEL PUNZONE PER CONTRASSEGNA RE

PROFONDITA INTAGLIO 0,5 MM

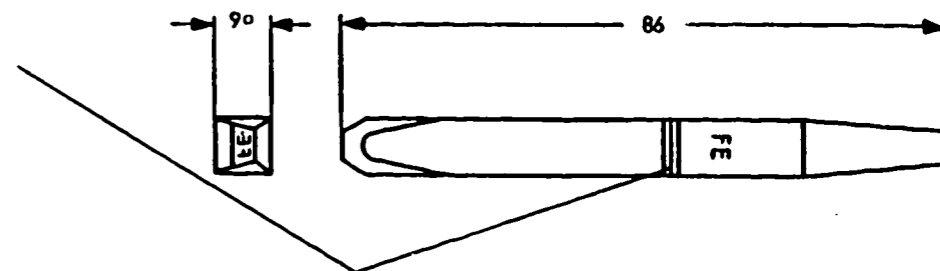

ESEMPI DI CONTRASSEGNI PUNZONATI

SCALA 2 : 1

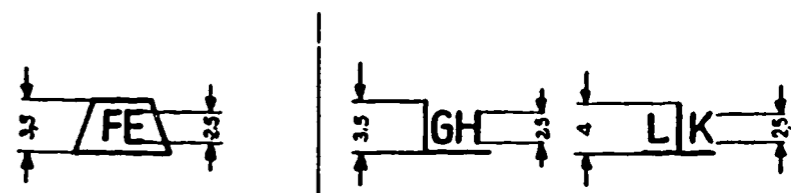



A

AA 7080 Aalen: Josef Lipp
AB 8750 Aschaffenburg: Wilhelm Wissel KG mit Zweigbetrieb Miltenberg
AC 5420 Lahnstein 2: Gerhard Zmely
AD 6740 Landau/Pfalz: Gerd Mayr
AE 3320 Salzgitter-Lebenstedt: Elektro-Dieseldienst GmbH
AF 2960 Aurich: Lothar Freese
AG 8900 Augsburg: Otto Dürr KG
AH 8800 Ansbach: Carl Bossert OHG
AI 0-5320 APOLDA: Joachim Schneider
AJ 0-5210 Arnstadt: Elektro-Dienst GmbH
AK 4730 Ahlen: Ahlke GmbH
AL 7150 Backnang: Emil Alber
AM 3000 Hannover: Ing. Otto Meyer GmbH & Co.
AN 5100 Aachen: C.J. Schmitz KG
AO 8900 Augsburg-Lechhausen: Otto Höppel KG
AP 6320 Alsfeld 1: Pavel KG
AR 8450 Amberg/Opf.: Josef Rothammer
AS 5230 Altenkirchen: Schmidt OHG
AV 8750 Aschaffenburg: Götz Auto-Elektrik GmbH
AW 4422 Ahaus: A. Coler
AY 6508 Alzey: Auto-Elektrik- und Dieseldienst Faber KG
AZ 2100 Hamburg 90: Carl Zöger

B

BA 8580 Bayreuth: Knoll Service GmbH
BB 0-2560 Bad Doberan: Uwe Boock
BC 1000 Berlin 37: Joachim Scherbarth
BD 1000 Berlin 30: Pumpen-Schulze
BE 1000 Berlin: Robert Bosch GmbH Verkaufshaus
BF 4630 Bochum: Fischer & Rohlsen
BG 4933 Blomberg: Bernert GmbH & Co. KG
BH 3300 Braunschweig-Weststadt Kurt Rauch
BI 4800 Bielefeld: Josef Kalveram
BJ 0-7232 Bad Lausick: Lutz Schmidtke
BL 7030 Böblingen: Robert Groß
BM 6749 Pleisweiler-Oberhofen: BZA-Auto-Elektrik GmbH
BN 0-7582 Bad Muskau: Reinhold Klepsch
BO 5300 Bonn: Brunn GmbH & Co.
BP 7570 Baden-Baden: Michael Schmidt
BR 2800 Bremen 1: Bruno Schmidt
BS 1000 Berlin 20: Josef Vogel
BT 0-8600 Bautzen: Albert Lehner
BU 5550 Bernkastel-Kues: Ing. Leo Becker
BV 4290 Bochold i.W.: Heinrich Kalkofen
BW 1000 Berlin 31: Gustav Gabriel GmbH
BX 2800 Bremen 1: Müller + Siemer
BY 0-1170 Berlin: EWEKö Elektrowerkstatt Köpenick



C

CB 0-9072 Chemnitz: Rolf Fischer
CC 4620 Castrop-Rauxell: Karl Schween
CE 3160 Celle: AED GmbH
CH 0-7501 Cottbus-Dissenchen: E. Hennig
CK 5100 Aachen-Brand: Johann Klubert Autoelektrik GmbH
CL 4550 Brämsche 3-Achmer: Gisbert Landefeld
CM 0-2752 Schwerin: Mecklenburgische Maschinenbau & Landtechnik GmbH
CN 0-9044 Chemnitz: Knoll GmbH
CR 4620 Castrop-Rauxel II: Bernhard Nowicki
CS 4420 Coesfeld: Karl Schlüter
CW 7060 Schorndorf: Peter Meyer
CX 0-9630 Crimmitschau: Bernd Rose

D

DA 4930 Detmold: Paul Altekrüger
DC 0-7270 Delitzsch: Joachim Wernicke
DD 4000 Düsseldorf: Anton Dingerkus
DE 2870 Delmenhorst: Werner Oberheide KG
DF 4000 Düsseldorf: Paul Soeffing GmbH & Co.
DG 5270 Gummersbach 21-Derschlag: Udo Manthey
DH 4502 Bad Rothenfelde: Walter Hagmeier
DI 0-8020 Dresden: Auto-Elektrik Fuhrmann
DJ 2845 Danne: Janssen GmbH
DK 7552 Durmersheim: Bruno Kinberger
DL 2840 Diepholz: Karl-Gerd Waldemair
DM 5568 Daun: Jakob Weiler KG
DN 4600 Dortmund-Körne: Wilfried Hentrich
DO 4600 Dortmund: Eugen Boss KG
DP 8360 Deggendorf: Zweigbetrieb H. Pregler KG, Straubing
DR 4000 Düsseldorf: Werner Wüsten
DS 7710 Donaueschingen: Josef Siraky
DT 6100 Darmstadt: Franz Strobl
DU 4100 Duisburg: Wagener & Schade
DV 0-8020 Dresden: Mezger + Schlag GmbH
DW 4600 Dortmund-Hoerde: Zweigbetrieb Eugen Boss KG
DX 0-8028 Dresden: Axel Oehlschläger
DY 0-8051 Dresden: Klaus Missbach
DZ 5160 Düren: Willi Zywock

E

EA 4300 Essen 1: A. Struck
EB 5828 Ennepetal-Milspe: S. Bubenzer & P. Bock
EC 2970 Emden: Flink & Peters GmbH
ED 7830 Emmendingen: E. Schmolck GmbH
EE 4407 Emsdetten: Ludwig Klaps GmbH & Co. KG
EG 4300 Essen-Borbeck: Gerhardt GmbH
EH 4720 Beckum: Paul Horstmann
EI 7470 Albstadt 1: Ernst Lorch KG
EJ 0-1300 Eberswalde-Finow: Werner Jorde



E

EK 0-9373 Ehrenfriedersdorf: Klopprogge
EL 8330 Eggenfelden: Zweigbetrieb Fr. X. Leitl KG, Neuötting
EM 6254 Elz: Ernst Müller
EN 4300 Essen: Wagener & Schade
EO 0-9703 Ellefeld: Wolfgang Eßbach
EP 5030 Hürth: Diesel-Sepp Peter Schindlbeck GmbH
ES 7300 Esslingen: Adolf Dörner KG
ET 0-5025 Erfurt: Hermann Stärker
EV 0-5900 Eisenach: Dieter Schöll
EW 5350 Euskirchen: Willy Weißweiler
EX 7505 Ettlingen: Richard Rettenmaier
EY 6753 Enkenbach-Alsenborn 1: August Werner
EZ 5140 Erkelenz: K. Schumacher

F

FA 6400 Fulda: Dipl.-Ing. Karl Schmitt
FB 0-9380 Flöha: Andreas Uhlig
FC 0-1200 Frankfurt/Oder: Mario Deppe
FD 8437 Freystadt: Auto Elektrik Dorr GmbH
FE 0-9200 Freiberg: Kfz-Elektrik Ehrhardt
FG 7800 Freiburg: Keller & Schneider GmbH
FI 2390 Flensburg: Iwersen GmbH
FK 7990 Friedrichshafen a.B.: Gert Veeseer
FL 2390 Flensburg: Stegner & Grundner GmbH & Co.
FN 6000 Frankfurt 60: Justus Kunz KG
FR 6000 Frankfurt/M.: Robert Bosch GmbH Verkaufshaus
FS 8510 Fürth 3: Fuchs GmbH
FU 6000 Frankfurt/M.-Ost: Zweigbetrieb Dipl.-Ing. K. Schmidt
FW 8228 Freilassing: Max Weber

G

GA 5130 Geilenkirchen-Niederheid: Alfons Schiffers
GB 0-6500 Gera: Richter
GC 4170 Geldern-Veert: Wagener + Schade GmbH
GD 7070 Schwäb.Gmünd: Ernst Deschler KG
GE 4390 Gladbeck: Klar + Schade GmbH
GF 0-8900 Görlitz: Hesse
GG 4650 Gelsenkirchen: Wulsch & Fest KG
GH 7560 Gaggenau-Ottenau/Baden: Peter Kolossa
GJ 0-5800 Gotha: H & K Auto GmbH
GK 5820 Gevelsberg: Klein & Wiese
GL 5070 Berg.-Gladbach: Hubert Kirch
GM 4048 Grevenbroich: Werner Mayer
GN 8780 Gemünden: Armin Eschenbacher
GP 0-5823 Gräfentonna: Hans-Jörg Werner
GR 4050 Mönchengladbach: Soeffing GmbH + Co.
GS 6300 Gießen: Ludwig Fetzer GmbH & Co. KG
GT 3400 Göttingen-Weende: Carl Sommer
GU 4830 Gütersloh: Walter Sieg OHG

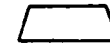

G

GW 0-2600 Güstrow: A. u. D. Plaschek
GX 3380 Goslar: Ing. Otto Meyer GmbH & Co. KG
GY 5940 Lennestadt 11-Grevenbrück: Josef Dolle
GZ 4504 Georgsmarienhütte: Karl-Heinz Scholz

H

HA 5800 Hagen: Eugen Boss KG
HB 6900 Heidelberg: Horst Blickle GmbH
HC 0-4010 Halle: Fischer & Röhle
HE 7100 Heilbronn: Dieterich GmbH & Co.
HF 4352 Herten: Hans Boesner GmbH, Zweigbetrieb
HG 2000 Hamburg 26: Alfred Kruse Nachf.
HH 8552 Höchststadt/Aisch: Hirsch GmbH
HI 0-4016 Halle-Diemitz: Dieter Franke
HJ 6900 Heidelberg: L. Fath-Trippmacher, Inh. Georg Fath-Trippmacher
HK 3450 Holzminden: Ing. Karl Rabke, Inh. F. Pfannkuche
HL 2250 Husum: Walter Kessler
HM 4700 Hamm: A. Coler
HN 5800 Hagen: Ing. August Barlmeyer
HO 8670 Hof: Böhringer & Zapf GmbH
HP 2000 Hamburg 70: Autoelektrik- und Dieseldienst GmbH
HR 3000 Hannover: Robert Bosch GmbH Verkaufshaus
HS 6450 Hanau: Hans-Jürgen Schwab
HT 3000 Hannover-Vahrenwald: Ernst-Günther Maurer GmbH
HV 4010 Hilden: F. Herchenhan Inh. Ing. W. Orth
HW 2000 Hamburg 63: Wilhelm Kuhlmann, Inh. Wolfgang Krause
HX 3250 Hameln: Alfred Reichelt KG
HZ 4320 Hattingen: Hans Boesner GmbH

I

IA 0-6301 Ilmenau-Roda: RKT Reumann KFZ-Technik
IB 6580 Idar-Oberstein 4: Wilhelm Busch KG
IC 6290 Weilburg: Courtin GmbH
ID 5560 Wittlich: Dorner GmbH
IG 8710 Kitzingen: Rudolf Grötsch
IH 4530 Ibbenbüren-Alstedde: Autotechnik H. + W. GmbH
IK 4950 Minden-Hahlen: Josef Kalveram
IL 5900 Siegen 31: Herbert Wildraut
IM 2300 Kiel-Mettenhof: Marx GmbH
IO 5248 Wissen/Sieg: Richard Römer
IP 4800 Bielefeld-Sennestadt: Flöger Kfz-Technik GmbH
IR 5520 Bitburg: Hans Riewer KG
IT 6507 Ingelheim: Hugo Theuerkauf

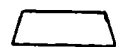

J

JA 0-1700 Jüterbog: Arnold Lindner
JB 5300 Bonn: Brunn KG
JC 2112 Jesteburg: Wolfgang Schween
JG 0-6900 Jena: Gerold Auto-Licht
JN 2942 Jever: Helmut Nicolai
JD 5170 Jülich: H.J. Zopp, Autoelektrik
JR 0-6901 Jena-Wöllnitz: Stefan Reinhold
JS 8070 Ingolstadt: Müller & Co GmbH
JZ 2210 Itzehoe: Ing. Gustav Grewe Nachf.

K

KA 3500 Kassel: Ludwig Wagener KG, Inh. Hans Thiel Nachf.
KB 8630 Coburg: Manfred Knoll
KD 5000 Köln-Deutz 21: Jakob Daub & Sohn OHG
KE 2300 Kiel 14: Werner Droege KG
KF 8950 Kaufbeuren: Anton Miehler
KG 5000 Köln 30: Gottfried Neuerburg GmbH & Co. KG
KH 0-8293 Königsbrück: Günter Freudenberg
KI 6798 Kusel: Paul Königstein
KJ 8960 Kempten: Michael Nußrainer
KK 0-4370 Köthen: Wiesner Autoelektrik
KL 6750 Kaiserslautern: Willi Henn GmbH
KM 8650 Kulmbach: Knoll GmbH
KN 5000 Köln 51: Paul Klünter
KO 5000 Köln: Robert Bosch Verkaufshaus
KP 3500 Kassel: Helmut Knobloch & Sohn
KS 5400 Koblenz: Philipp Scherer KG
KT 7750 Konstanz: Albert Siegle, Inh. Daniel Siegle
KU 7500 Karlsruhe 21: Horst Blickle GmbH + Co.
KV 0-1910 Kyritz: Günter Schumann
KW 5000 Köln-Mülheim 80: Wissner & Münch GmbH & Co.
KX 5000 Köln 40-Marsdorf: Wwe. Mertlich Inh. A. Steinbach OHG
KY 5000 Köln-Ostheim 91: Andreas Schramm
KZ 6747 Kandel: Eckhard Adler

L

LA 4910 Lage: Adolf Biker
LB 2400 Lübeck: Schöberl & Co.
LC 8990 Lindau: Henry Bauer
LD 7140 Ludwigsburg: Erwin Sulzberger
LE 3140 Lüneburg: Ing. Otto Milwa
LF 8882 Lauingen: Günter Stein
LG 6250 Limburg: Phillip Scherer GmbH & Co. KG
LH 7850 Lorrach: J. Schmid GmbH
LI 4780 Lippstadt: August Coler GmbH
LK 0-9251 Lauenhain: Bernd Leukert
LM 4628 Lünen: Wilhelm Blumenkeper KG
LN 4540 Lengerich-Hohne: Hünefeld GmbH
LO 4920 Lemgo: Herbert Thorn

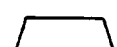

L

LP 7958 Laupheim: Rolf Eble
LR 8910 Landsberg: Helmer & Richter
LS 6700 Ludwigshafen: Ing. W. & F. Seitz KG
LT 8300 Landshut: Käufel GmbH
LU 5880 Lüdenscheid: Wilhelm Schöneborn Nachf. KG
LV 5090 Leverkusen-Küppersteg: Zweigbetrieb Neuerburg GmbH & Co. KG
LW 6790 Landstuhl: Theiß
LY 6610 Lebach: Weber GmbH

M

MA 4130 Moers: Ing. Heinrich Kratz
MB 8000 München 50: Georg Breit
MC 0-3010 Magdeburg: Auto-Licht Magdeburg GmbH
ME 8000 München 2: Zweigbetrieb Meinburk, Meineke GmbH
MF 5430 Montabaur-Heiligenroth: Heinrich Keuler
MG 8000 München 80: Grieb & Hofmann
MH 5552 Morbach: Franz Josef Zerwes
MI 0-3023 Magdeburg: Jürgen Behrens
MJ 0-1201 Frankfurt-Markendorf: Gerhard Wasmund
MK 6800 Mannheim: Horst Blickle GmbH
ML 3550 Marburg: Dieter Stallberg
MM 8000 München 45: Meinburk, Meineke GmbH
MN 8940 Memmingen: Josef Lipp GmbH & Co.
MO 5778 Meschede: Josef Joachimsmeier OHG
MP 4470 Meppen: Neuhäuser & Ortmann
MR 4400 Münster: A. Coler
MS 0-8250 Meißen: Ralf Welk
MT 8260 Mühlendorf: Zweigbetrieb Fr.X. Leitl KG, Neuötting
MU 8000 München: Robert Bosch GmbH Verkaufshaus
MW 6800 Mannheim: Hans-Joachim Courtin
MX 6120 Michelstadt: Werner Krämer
MY 5439 Bad Marienberg: Willi Panthel KG, Inh. Klaus Panthel
MZ 6052 Mühlheim/Main: Hermann Kapp

N

NA 6680 Neunkirchen: Rolf Schneider
NB 4040 Neuß: Bienenfeld OHG
NC 5483 Bad Neuenahr-Ahrweiler 1: Theo Weißweiler
ND 8740 Bad Neustadt: Hermann Endrich
NE 2350 Neumünster: Droege + Koch GmbH
NF 0-4800 Naumburg: Frank Bönisch
NG 0-9154 Niederdorf: Gerd Gränz
NH 0-5500 Nordhausen: Wenkel GmbH
NI 8500 Nürnberg: O. und H. Schmidt KG
NK 6730 Neustadt: Fritz Kuby jun.
NM 3070 Nienburg: Bengen GmbH
NN 4460 Nordhorn: Ludwig Klaps
NO 7270 Nagold: Hermann Oesterle KG
NP 8674 Naila: Paul Hohmann



N

NR 8430 Neumarkt: Peter Edenharder
NS 5281 Gummersbach-Niedersessmar: Alfred Schmidt
NT 8262 Neuötting: Franz Xaver Leitl KG
NU 8500 Nürnberg 23: Koller & Schwemmer GmbH
NV 5450 Neuwied 1: Vogtmann-Herold & Co. GmbH
NW 7440 Nürtingen: Theodor Wagner
NY 0-8706 Neugersdorf: Peter Tempel

O

OA 4200 Oberhausen 1: Auto-Elektrik und Dieseldienst H. Osterkamp KG
OB 7600 Offenburg: Keller & Schneider GmbH
OC 5300 Bonn-Beuel: Manfred Schattevoy
OD 2900 Oldenburg: Martin Kickler KG
OG 4200 Oberhausen: Fritz Gröninger
OH 4200 Oberhausen 11/Sterkrade: Weller & Hofmann GmbH
OI 2860 Osterholz-Scharmbeck: Gebr. Fritz GmbH & Co. KG
OJ 0-9330 Olbernhau: Christian Ceipek
OK 4500 Osnabrück: Karl Haug KG
OL 4250 Bottrop: Klar & Schade GmbH
OM 7602 Oberkirch: AE Meier GmbH
ON 0-7260 Oschatz: Weber GmbH
OP 4811 Oerlinghausen-Helpup: Karl-Friedrich Flöger
OR 4500 Osnabrück: Dieter Hartlage GmbH & Co. KG
OS 2440 Oldenburg: Franz Schöning
OU 8671 Oberkotzau: Hermann Böhringer GmbH
OW 6760 Rockenhausen: Werner GmbH

P

PB 0-2100 Pasewalk: Autohaus Pasewalk GmbH
PC 3150 Peine: Hans Macke
PD 0-2910 Perleberg: Uwe Jansen
PE 8350 Plattling: Helmut Eimer
PF 7417 Pfullingen: Gottlob Maier
PG 8922 Peiting: Hans Hirschvogel KG
PH 4790 Paderborn: Hentze GmbH
PI 0-8300 Pirna: Autoelektrik Bretschneider
PJ 6780 Pirmasens: Ernst Stürzenberger OHG
PK 0-8300 Pirna: Wolfgang Schelzig
PL 0-1503 Potsdam-Bornstedt: Peter Schmohl
PM 3150 Peine: Ewald Meyer
PO 8398 Pocking: Konrad Urlhart
PP 5540 Prüm: G. & P. Papkalla
PS 6102 Pfungstadt: Heinrich Stephan
PU 8123 Peißenberg: Alfred Ruprich
PW 3280 Bad Pyrmont: Franz Welger
PX 5970 Plettenberg: Armin Pacem

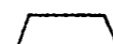

R

RA 4030 Ratingen: Werner Krause
RB 7550 Rastatt: Braunagel & Brandt GmbH
RC 8230 Bad Reichenhall: Hubert Bichlmaier
RD 5630 Remscheid: Edmund Klaiss OHG
RE 2370 Rendsburg: Heinrich Kirchner
RF 0-1822 Brück: Lutz Wiesenburg
RG 8400 Regensburg: Küblbeck & Schmidt GmbH & Co.
RH 4440 Rheine: Ludwig Klaps KG
RJ 6831 Reilingen: Otto Jourdan GmbH
RK 7980 Ravensburg: Ernst Lorch KG
RM 4788 Warstein: K.H. Modrow
RN 1000 Berlin 62: Auto-Licht-Gesellschaft Gebr. Roskoden
RO 7211 Rottweil: Bruno Müller
RP 5910 Kreuztal: Jürgen Pfeifer
RS 8200 Rosenheim: Karl Schmitz KG
RT 7410 Reutlingen: Gert Gokenbach
RU 2842 Lohne: Ludwig Südbeck Jun.
RV 0-1955 Rheinsberg: Werner Tornow
RW 5630 Remscheid-Hasten: K.W. Noll
RX 4292 Rhede: Heinrich Kalkofen
RY 4050 Mönchengladbach 2 (Rheydt): Hutmacher GmbH
RZ 0-1830 Rathenow: Heinz Krüger GmbH

S

SA 7968 Saalgau: Waldemar Blickle
SB 5900 Siegen: Max Grieb KG
SC 8920 Schongau: Elektro-Hirschvogel GmbH
SD 5190 Stolberg: Karl Derichs
SE 4770 Soest: Heinrich Tölle
SF 0-6800 Saalfeld (Saale): Herbert Pfister
SG 8440 Straubing: Hans Pregler KG
SH 8720 Schweinfurt: Mezger-Schlag GmbH
SI 0-4701 Sangerhausen-Oberröblingen: Henry Stutika
SJ 5900 Siegen: Richard Römer
SK 2838 Sulingen: Auto-Licht-Lütge
SL 6600 Saarbrücken: A. Lichius GmbH
SM 0-2556 Sanitz: Fritz Engelbrecht
SN 2160 Stade: Hans Nagel
SO 5650 Solingen, Karl Röhrle
SP 5200 Siegburg: Hans Gerd Krusen KG
SR 0-9412 Schneeberg: Gunther Meißner
SS 7000 Stuttgart 60: Fritz Trost KG
ST 7000 Stuttgart: Robert Bosch GmbH Verkaufshaus
SU 7000 Stuttgart 30: Fritz Trost KG
SV 0-9801 Schönbrunn: Peter Walter
SW 5190 Stolberg: Wynands GmbH
SX 7700 Singen: Rudolf Elsässer KG
SY 7170 Schwäb.Hall: Ernst Deschler KG
SZ 6720 Speyer: Vögeli & Sohn



T

TA 8391 Tittling: Reinhard Haas
TC 0-2110 Torgelow-Spechtberg: Fritz Siegel
TD 5500 Trier: Dorner & Volbach
TH 4803 Steinhagen: Manfred Horstkötter
TJ 7000 Stuttgart 1 (Süd): Karl Schellhorn GmbH
TK 2117 Tostedt: Rudolf Kröger
TN 8220 Traunstein-Haslach: H & W Autoelektrik GmbH
TP 0-7127 Taucha: Bernd Peper
TR 5500 Trier: Jakob Weiler KG
TS 5210 Troisdorf-Oberlar: M. Schattevoy GmbH
TT 0-6418 Sonneberg: Thomas Thömmes
TU 7400 Tübingen: Gert Gockenbach
TW 7200 Tuttlingen: Otto Stoffel

U

UA 7900 Ulm/Donau: Julius Mack GmbH & Co. KG
UB 7700 Überlingen: Hans Bolter
UC 2400 Lübeck: Schiefer-Autoelektrik GmbH
UF 5160 Düren-Gürzenich: Erwin Frost
UG 0-2620 Bützow: Christoph Moritzen
UH 4750 Unna-Königsborn: Heisel & Heiner OHG
UI 0-5232 Buttstädt: Christian Pohl
UJ 3167 Burgdorf: Hans Joachim Müller
UM 7910 Neu-Ulm: Otto Dürr KG
UD 5600 Wuppertal 11: Peter Hoffmann
UR 8458 Sulzbach-Rosenberg: Georg Brunner
US 7580 Bühl-Altschweier: Michael Schmidt
UT 8521 Uttenreuth: Hirsch GmbH & Co. KG
UW 8000 München 70: Wiehler & Hartl
UX 8044 Unterschleißheim: AES GmbH
UZ 3110 Uelzen-Veerssen: Max Egon Hedrich

V

VA 3090 Verden: Ernst Ebersberger GmbH
VB 4630 Bochum-Harpen: Hans Boesner GmbH
VD 7730 Villingen: Gerhard Dorer KG
VE 4804 Versmold: Günther Wesselmann
VJ 2848 Vechta: Arno Janssen
VL 6806 Viernheim: Horst Lierke
VT 5620 Velbert: Oskar Tausenberger

W

WA 0-1292 Wandlitz: Dieter Birlem
WB 5810 Witten: Bendick & Czech
WC 6330 Wetzlar-Steindorf: Courtin GmbH
WD 8480 Weiden: Küblbeck & Schmidt GmbH & Co.
WE 2850 Bremerhaven 1: Gummi Hasenkrug



W

WF 0-5300 Weimar: Andreas König
WG 8706 Höchberg-Würzburg: Mezger-Schlag GmbH & Co.
WH 2940 Wilhelmshaven: Schmidt
WI 0-1512 Werder: Horst Bader
WJ 4230 Wesel: Wagener & Schade GmbH
WK 4840 Rheda: Kalveram GmbH & Co. KG
WL 8592 Wunsiedel: Manfred Bleil
WM 6940 Weinheim a.d. Bergstraße: Bix KG
WN 6202 Wiesbaden: Gebr. Schäufele GmbH
WO 6520 Worms: Bormuth & Jung
WP 4410 Warendorf: A. Coler
WR 5220 Waldbröl: Martin Rahn
WS 6520 Worms: Gustav Sauer
WV 3583 Wabern: H. Günther GmbH & Co. KG
WW 8832 Weißenburg: Robert Walloschke
WX 3530 Warburg: Heribert Hendker
WY 5900 Siegen 21-Weidenau: Ulrich Althaus

X

XA 6450 Hanau: C. Ruppel & Co.
XB 4800 Bielefeld 14: Traphöner KG
XC 6490 Schlüchtern: Dieter Schlichting & Co.
XD 7320 Göppingen: Ernst Deschler KG
XF 2000 Hamburg 26: Peter Frischholz
XH 7480 Sigmaringen: Günter Hirz
XI 2380 Schleswig: Marx GmbH
XJ 0-1144 Berlin-Kaulsdorf: Erich Müller
XK 6701 Maxdorf: Alfons Wiebelskircher
XL 6620 Völklingen: Welker GmbH
XN 0-8272 Brockwitz: Frank Cipa
XO 2000 Oststeinbek: Gerd Ruks
XR 2050 Hamburg 80: Günther Ritter
XS 2347 Süderbrarup: König & Kock
XT 4630 Bochum-Weitmar: Gerd Stemmer
XV 6920 Sinsheim: Klaus Kirsch
XW 2100 Hamburg 90: Herbert Seidel
XY 0-2380 Barth: Arnim Goldenbogen
XZ 6806 Viernheim: Hans Wittich

Y

YA 5600 Wuppertal-Elberfeld: Gerrit Hauptmann
YB 5678 Wermelskirchen: Volker Bernhard
YD 6980 Wertheim: Dinkel GmbH
YF 6466 Gründau: G.W. Fischer GmbH
YH 8640 Kronach: Günter Hoffmann
YI 8520 Erlangen: Hirsch KG
YK 7520 Bruchsal: Klaus Stauder
YL 4432 Gronau: Heinz Feldhaus
YM 4900 Herford: Wilfried Lampe

6. BUNDESREPUBLIK DEUTSCHLAND, FED. REP. OF GERMANY, REP. FED. D ALLEMAGNE,
REP. FED. DE ALEMANIA, REP. FED. DI GERMANIA,



Y

YN 5202 Hennef 1: Waldemar Knipp
YD 2257 Breklum: Autoelektrik Hörcher
YR 6070 Langen: Rehwald GmbH & Co. KG
YS 3410 Northeim: Jürgen Himstedt
YT 3000 Hannover: Gerhard Timm
YW 6968 Walldürn: Wörner GmbH & Co. KG
YZ 7460 Balingen: Leopold Zimmermann

Z

ZA 0-1434 Zehdenick: Erhard Schulz
ZB 7520 Bruchsal: Anton Bürk
ZC 8898 Schrobenuhausen: Hans Kastl
ZD 0-1297 Zepernick: Horst Bäker
ZE 0-6570 Zeulenroda: Feig
ZF 6720 Speyer: Udo Friedenberger KG
ZG 4520 Melle: Gerhard Specht GmbH
ZH 7950 Biberach: Autoelektrik Högerle
ZI 0-8800 Zittau: Frieder Steudte
ZJ 0-9540 Zwickau: Dörfelt GmbH
ZK 7500 Karlsruhe: Karl Bär GmbH
ZM 5060 Bergisch-Gladbach: Müller
ZN 5000 Köln 30: Erich Nietzel
ZO 0-9560 Zwickau: Helmut Heidrich
ZP 2730 Zeven: Pawlak & Co. GmbH
ZR 6600 Zweibrücken: Fritz Reinhard
ZS 4960 Stadthagen: Hermann Steckhan
ZU 8728 Hassfurth: Heinz Betz
ZX 5300 Bonn-Endenich: Hermann Kopp
ZY 7573 Sinzheim: Hans Joachim Bauer
ZZ 7518 Bretten: Hubert Betsche

A

AA 5205 St. Augustin 2: G. Alberti GmbH
AB 7590 Achern/Baden: Jürgen Fritsch
AG 5470 Andernach: Horst Göddertz
AH 5760 Arnsberg: Hechler & Schütz
AN 8750 Aschaffenburg: Autoelektrik Neuwirth GmbH
AO 5990 Altena/Westf.: Günter Klapper
AP 4700 Hamm 1: Pieper Autoelektrik
AS 7452 Haigerloch: Josef Schramm
AW 5940 Lennestadt 1/Altenhundem: Manfred Woite
AY 5110 Alsdorf: Hermann Quiter

B

BA 1000 Berlin 21: Auto-Technik Tiergarten
BB 7120 Bietighcim: Karl Breier
BC 1000 Berlin 19. Auto-Licht Holtz & Co.
BD 6550 Bad Kreuznach: Heinz Keller
BE 1000 Berlin 44: Feichtinger & Wachholz
BF 5300 Bonn-Bad Godesberg: Johann Bartsch
BG 5010 Bergheim-Niederlaufem: Ulrich Glaswacher
BH 8939 Bad Wörishofen: Jakob Holder
BI 2800 Bremen: Ewald Genoux
BJ 5040 Brühl: Jakob Schmitz
BK 2150 Buxtehude: Georg Ludwig Müller
BM 6588 Birkenfeld/Nahe: Paul Mildenberger
BN 0-1040 Berlin: Wolfgang Wappler
BO 0-1120 Berlin: Uwe Bakalosch
BP 0-1185 Berlin-Altglienicke: Georg Zapke
BR 4280 Borken: Bernhard Niermann
BS 2830 Bassum: Ernst Sagemann
BT 0-1140 Berlin-Marzahn: Peter Vogelreuter
BU 3590 Bad Wildungen: H. Günther GmbH
BV 0-1110 Berlin-Pankow: Egon Tietz
BW 1000 Berlin 21: Heinz Wisbar Nachf.
BX 0-8500 Bischofswerda: Kurt Reitner
BY 0-4400 Bitterfeld: Heyland & Koller GmbH
BZ 7030 Böblingen: Albert Wurster KG

C

CA 0-9023 Chemnitz: Chemnitzer Autoservice und Elektrik GmbH
CE 8490 Cham-Janahof: Michael Heller
CH 5590 Cochem-Brauheck: Klaus Heinze
CL 7730 Villingen-Schwenningen: Lieb KG
CR 3100 Celle: Wilfried Rehwinkel
CS 7180 Crailsheim: Martin Frank

D

DB 4220 Dinslaken: Brodkorb GmbH & Co. KG
DC 4000 Düsseldorf-Rath: Werner Schirmer
DE 4408 Dülmen: Ewald Lappessen
DI 8312 Dingolfing: Robert Mißlinger
DL 4270 Dorsten: Adler Auto-Elektrik
DR 0-4506 Dessau-Mosigkau: Frank Richter
DS 4047 Dormagen 1: Jost Spinrath
DV 4100 Duisburg: Heinrich Vogt
DW 6638 Dillingen: Weber GmbH

E

EA 6719 Eisenberg: Wolfgang Baumann
EB 0-7904 Elsterwerda: Dirk Brundisch
ED 6101 Messel: Franz Denk
EE 3352 Einbeck: Dieter Berger
EH 6930 Eberbach: Karl Schmitt
EI 6455 Erlensee: Hans-Jürgen Schwab
EK 4300 Essen-Borbeck: Klaus Kolling
EL 0-1170 Berlin: ALS Auto Lehmann Süd
EM 5450 Euskirchen: Werner Müller
EO 3210 Elze 1: Kfz-Elektrik Köhler
ES 3440 Eschwege: Harry Sterzing
ET 4240 Emmerich: TEBA-Intratechnik
EW 3436 Hessisch Lichtenau: Hans Dieter Walenta
EY 0-4250 Eisleben: H. Knorrscheid

F

FA 0-1540 Falkensee: Hans-Werner Auping
FB 6000 Frankfurt/M. 1: Eberhard Blank
FE 7012 Fellbach: Klaus Ernst
FF 3558 Frankenberg: Rudolf Fiedler KG
FK 8958 Füssen: Robert Stöhr
FL 5905 Freudenberg-Oberfischbach: Burghard Loos
FO 0-2003 Friedland: Axel Oehmke
FR 7800 Freiburg: Günther Reichenbach
FS 8481 Flossenbürg: Heinz Strunz
FW 0-1240 Fürstenwalde: Hans-Jürgen Wanke
FZ 6000 Frankfurt 61: Zöller Fahrzeugwerkstatt GmbH

G

GA 0-2200 Greifswald: Hans Sass
GB 4830 Gütersloh: Fritz Beckord
GC 0-2730 Gadebusch: Jürgen Pawelzik
GF 0-7243 Großbothen: Arndt Finkas
GI 0-3561 Gieseritz: H.-G. Broweleit
GK 0-6504 Gera-Bieblach: Knoll GmbH
GL 5530 Gerolstein: Willi Ludowicy

G

GM 4402 Greven: Josef Dambacher
GO 0-5800 Gotha: H. Michael GmbH
GP 8100 Garmsisch-Partenkirchen: Peter Spanier
GR 0-7501 Gallinchen: Braunstein
GS 6300 Lahn-Gießen: Schäfer & Heinrich
GT 4180 Goch: B.J. Tück
GV 8723 Gerolzhofen: R. Vad GmbH
GW 7411 Engstingen 1: Karl Werner

H

HB 2000 Hamburg 50: Koberger & Sohn
HE 3520 Hofgeismar: Albert Hein
HG 7100 Heilbronn: Vogelmann GmbH
HH 2000 Hamburg 71: Klietsch & Kummer
HI 3250 Haseln: Kurt Abbing, Nachf. Manfred Bublitz
HK 4435 Horstmar: Alfred Kösters
HM 0-4321 Heteborn: Mechnik Auto-Service
HN 3000 Hannover: Hans Habenicht
HO 0-7701 Hoyerswerda-Zeissig: Rolka GmbH + Co.
HP 2000 Hamburg 13: Hermann Wittkamp
HR 2000 Hamburg 76: Walter Fiedler
HT 6650 Homburg/Saar: Auto-Elektrik Stempel
HU 7920 Heidenheim-Schnaitheim: Georg Guemper GmbH
HV 7613 Hausach i. Kinzigtal: Kurt Vetter
HW 8759 Hösbach/Feldkahl: Wolfgang Weinmann
HX 3510 Hann.-Münden: Autoelektrik Neumünden GmbH

I

ID 3560 Biedenkopf-Wallau: Dersch & Balzer
IF 7118 Künzelsau-Gaisbach: Fischer GmbH
IK 5172 Linnich: Hans Küppers
IM 7132 Illingen: Gerhard Maulick
IR 0-6301 Ilmenau-Roda: RKT Reumann KFZ-Technik
IW 5860 Iserlohn: Karl Wessalowski GmbH

K

KA 3500 Kassel: Rolf Günther
KB 4190 Kleve: Leo Beyerink
KC 8782 Karlstadt: Armin Eschenbacher
KD 0-1910 Kyritz: Kyritzer Kraftverkehrs Gesellschaft mbH
KE 0-8361 Krumhermsdorf: Bernd Göbel
KF 5000 Köln 50 (Godorf): Kirfel & Faul
KH 8730 Bad Kissingen: Gerhard Häckner
KI 4150 Krefeld 1: Gerhard Kaisers GmbH
KK 5000 Köln 30: Herbert Kermer
KL 6719 Kirchheimbolanden: Günter Linn
KM 5000 Köln 71: Hans Gerhard Jobi

K

KO 8908 Krumbach: Rudolf Kober
KP 7500 Karlsruhe: Rolf Pieck GmbH & Co.
KS 8901 Königsbrunn: Manfred Steininger
KT 4150 Krefeld: Gustav Theurer
KU 4044 Kaarst 1: Hütten GmbH
KW 7014 Kornwestheim: Wolfgang Wegst GmbH

L

LA 2950 Leer: A & W Kfz-Elektrik
LB 0-7010 Leipzig: Hans-Eckhardt Gliesche
LC 8506 Langenzenn: Georg Christgau
LD 4990 Lübbecke: Deerberg Fahrzeugelektrik & Technik
LE 0-9102 Limbach-Oberfrohna: Hans Bernhard
LF 0-7142 Lindenthal: Autoelectric Scheil
LG 6758 Lauterecken/Glan: Horst Heß
LI 0-7010 Leipzig: Auto-Elektrik & Technik GmbH
LK 7630 Lahr: Heitzmann GmbH
LL 6970 Lauda-Königshofen: Heinz Klingert
LM 2400 Lübeck: Marx GmbH
LN 4450 Lingen: NEUORT Auto-Elektrik
LO 7140 Ludwigsburg: H. Hochstrasser
LR 6740 Landau/Pfalz: Karlheinz Roth
LS 6646 Losheim: Manfred Schulligen
LT 8560 Lauf: Friedrich Städtler
LU 6312 Laubach 4: Klaus Gülle
LW 8380 Landau: Alois Waas
LX 8058 Erding: Herbert Kahl
LZ 0-2800 Ludwigslust: Bert Schulz

M

MA 7130 Mühlacker: Manfred Laubscher KG
MC 0-3011 Magdeburg: Dr. Schmid GmbH
MD 0-5700 Mühlhausen: Reiner Zwinkau
ME 0-1203 Müllrose: D. Bentsch
MF 5403 Mühlheim-Kärlich: Wolfgang Frein
MG 8660 Münchberg: Seiferth Auto-Elektrik
MH 0-6100 Meiningen: Kamm Kfz-Elektrik
MI 4330 Mülheim: Diesel-Pitter GmbH
MJ 0-7981 Münchhausen: Werner Busse
MK 2222 Marne: Kölln GmbH
MM 6800 Mannheim: Karl Meckesheimer
MN 0-4200 Merseburg: Jens Kuntze
MR 6785 Münchweiler: Norbert Rung
MS 6640 Merzig: Gebr. Kess GmbH
MU 0-4275 Mansfeld: Autoelektrik u. Batterie-Service GmbH
MW 3508 Melsungen: Warenzentrale Hessenland GmbH

L

N

NE 4055 Nettetal/Kaldenkirchen: Leonhard Leven
NG 0-4901 Nonnewitz: Ralf Gerth
NK 5903 Neckargemünd: Rolf Kaufmann
NL 7270 Nagold: Alfred Kehle
NM 0-2080 Neustrelitz: Reinhard Kamke
NR 7129 Neckarwestheim: Jens Röhner
NT 8858 Neuburg/Donau: Johann Thumann
NX 2890 Nordenham-Blexersande: Hans Meinen
NZ 2350 Neumünster: Harry Schultz OHG

O

OB 7238 Oberndorf: Gerhard Gruhler
OC 4200 Oberhausen 12: H. und B. Cornelissen
OF 6050 Offenbach: Lothar Nennstiel
OK 0-3230 Oschersleben: Werner Kratzat
OR 6238 Hofheim: Wolfgang Mursall
OS 4630 Bochum 6: Uwe Stockmann
OW 6050 Offenbach: Weckesser & Fuchs
OZ 5090 Leverkusen 3: Gisela Rausch

P

PB 2990 Papenburg: Hermann Bunte GmbH
PH 7314 Wernau: Henni GmbH
PK 5024 Pulheim: Max Kratz
PS 0-1803 Brandenburg-Plaue: Moto-Tech GmbH
PT 8068 Pfaffenhofen: Bernd Tück GmbH
PW 8390 Passau-Haidehof: Hans Wimmer

R

RA 0-8400 Riesa: Ernst Tietze
RB 3300 Braunschweig-Querum: Reinecke & Breitkopf GmbH
RC 0-9706 Rodewisch: Rothe Autolicht
RD 0-2500 Rostock 6: Karl-Heinz Schwonbeck
RE 4350 Recklinghausen: W. Schlebusch
RF 2720 Rotenburg: Ottmar Freese
RG 2919 Uplengen-Remels: Gellermann Autoelektrik GmbH
RH 0-2510 Rostock: Uwe Burmeister
RI 7703 Rielasingen: Gebr. Singer
RJ 0-6820 Rudolstadt: K.H. Rusche
RL 0-5516 Ronneburg: Wismut Logistik GmbH
RN 4281 Raesfeld: Theo Niessing GmbH, Inh. W. Funke
RO 0-2500 Rostock: Hermann Grönhagen
RF 4050 Mönchengladbach 2: Hans Paulussen
RR 8803 Rothenburg o.T.: Helmut Reinold
RS 0-1803 Brandenburg-Plaue: Moto-Tech GmbH
RU 4534 Recke-Steinbeck: Rainer Gude
RW 6054 Rodgau 5: Herbert + Horst Weidler

L

R

RX 6054 Rodgau 3: Holger Wittig
RZ 8201 Raubling-Pfraundorf: Georg Zanetti

S

SA 6630 Saarlouis-Neuforweiler: Hans Steuer GmbH
SB 0-3300 Schönebeck: Bernd Ebeling
SC 0-1330 Schwedt: Siegfried Schreiber
SD 7032 Sindelfingen: Wolf Drücke GmbH
SE 6630 Saarlouis-Roden: Edmund Boudier KG
SF 0-2754 Schwerin: Michael Ahrenbeck
SG 7000 Stuttgart 80: Klaus Gebert
SH 0-7840 Senftenberg: Uwe Heduschka
SI 6902 Sandhausen: Otmar Rimmler
SJ 4815 Schloß-Holte-Stukenbrock: Jache GmbH
SK 5650 Solingen: Edmund Klais
SL 0-3500 Stendal: Carl Zöger GmbH & Co.
SM 0-2300 Stralsund: Peter Bartels
SN 5510 Saarburg: Helmut Neises
SO 0-1260 Strausberg: Roland Dörnbrack
SP 8540 Schwabach: Helmut Grampp
SR 8440 Straubing: Walter Dörfl
ST 6690 St. Wendel: Manfred Kohl
SU 0-6017 Suhl: Andreas Möller
SV 0-2355 Sassnitz: Fritz Plamper
SW 4401 Sendenhorst: Willi Holtkamp
SX 4281 Südlohn: Höing & Vedder
SY 0-6080 Schmalkalden: Hartmut Uloth

T

TH 8170 Bad Tölz: Franz Holnburger
TL 8593 Tirschenreuth: Josef Lang
TM 6693 Theley: Arnold Morbach
TS 7768 Stockach: Berthold Stengele
TW 0-2090 Templin: Woldt + Krüger

U

UA 3062 Bückeburg: Andreas Meier
UE 6390 Usingen: Bernard GmbH
UF 6470 Büdingen: Erwin Wahrenbruch
UH 7900 Ulm/Donau: Bernhard Simmendinger
UM 2082 Uetersen-Moorrege: Peter Meyn
US 3050 Wunstorf: Peter Sensch
UZ 7000 Stuttgart 60: Kral und Zeisel

7. BUNDESREPUBLIK DEUTSCHLAND, FED. REP. OF GERMANY, REP. FED. D ALLEMAGNE,
REP. FED. DE ALEMANIA, REP. FED. DI GERMANIA,

L

V

VA 4060 Viersen: Anzberger & Jäger OHG
VN 8313 Vilsbiburg: Joachim Nürnberg
VP 8358 Vilshofen: Michael Poisl
VS 2930 Varel i.O.: Alwin Söchting
VU 2057 Wentorf: Richard Buhck

W

WA 4100 Duisburg-Buchholz: Gerhard Markwitz
WB 5600 Wuppertal 1: Jürgen Blau
WC 7858 Weil-Haltingen: Günter Schwarzwälder
WD 0-8224 Wilsdruff: Christian Arnold
WE 0-3210 Wolmirstedt: A. Salender
WF 0-3700 Wernigerode: Wernigeröder Kfz-Elektrik GmbH
WH 2964 Wiesmoor: Schröder & Co. KG
WK 0-9533 Wilkau-Haßlau: Knoll GmbH
WL 8700 Würzburg: Erich Ihle
WM 8190 Wolfratshausen: Georg Malik
WO 7987 Weingarten: Helmut Blum, Nachf. Günter Ott
WP 0-7250 Wurzen: Günter Preil
WR 8480 Weiden: Hermann Rauh
WS 2280 Westerland/Sylt: Bernhard Dassler
WU 0-9611 Weidensdorf: Hausdorf, Kfz-Reparaturen und Elektrik
WY 6520 Worms: Heinz Schmitt

X

XA 2000 Hamburg 54: Michael Harms
XB 2140 Bremervoerde: Werner Junghans
XC 2370 Rendsburg: Harry Schiring
XE 5790 Brilon: F.J. Herting
XG 4570 Quakenbrück: Auto-Elektro-Dienst Alois Gürtler
XH 5042 Erftstadt-Lechenich: Johannes Henseler
XI 4232 Xanten: Bernd Ringelstetter
XK 2102 Hamburg 93: Klotz & Wedekind
XO 6350 Bad Nauheim 4-Steinfurth: Manfred Köcher
XR 7737 Bad Dürkheim: Jürgen Rauch
XS 2820 Bremen-Aumund: Fritz Schmidt
XW 7880 Bad Säckingen: Udo Weber

Z

ZB 0-7114 Zwenkau: Gottfried Böhmelt
ZF 8372 Zwiesel: Franz Forster
ZH 0-1807 Ziesar: Reinhard Helwich
ZL 6660 Zweibrücken: Jürgen Betz
ZX 2000 Hamburg 50: Lothar Korff

A

AA 2070 Ahrensburg: Hans-Joachim Ahlemann
AC 3000 Hannover 81: Wolfgang Schneider
AK 8074 Gaimersheim: Gerhard Knapp
AP 5952 Attendorn: Auto-Elektrik Josef Plugge
AR 6500 Mainz-Weisenau: Klemens Rudolf
AS 7321 Aichelberg: Rolf Straub
AW 6962 Adelsheim: Felix Windhager

B

BA 2360 Bad Segeberg: Kfz-Elektrik Letsch GmbH
BB 1000 Berlin 65: Braatz GmbH
BC 1000 Berlin 28: Schachtschneider & Stäglich
BD 4970 Bad Deynhausen: Detert GmbH & Co.
BE 4980 Bünde: Autoelektrik Gerhard Berens
BF 0-7152 Böhlitz-Ehrenberg: Mezger + Schlag GmbH
BG 8872 Burgau: Glink GmbH
BH 1000 Berlin 10: Holtz & Co.
BI 5060 Berg.-Gladbach: H.u.N. Wirbelauer GmbH
BJ 1000 Berlin 10: Norbert Huck
BK 2850 Bremerhaven-F.: Dieter Koch
BL 0-1800 Brandenburg: Alexander Karpow
BM 8580 Bayreuth: Mund GmbH
BN 1000 Berlin 41: Auto-Elektrik Steglitz GmbH
BP 4800 Bielefeld: Otto Haberkorn
BR 7024 Filderstadt: Jörn Jäger
BS 4902 Bad Salzflen: Schnatmeyer & Hellmeyer
BT 5070 Bergisch-Gladbach: Klaus Herweg GmbH
BU 5790 Brilon: Albert Lüke GmbH
BV 8600 Bamberg: Karlheinz Engert
BX 7187 Blaufelden: Werner Rapp
BY 3492 Brakel: Lemser Kfz-Elektrik
BZ 4290 Bocholt: Ludwig Degeling

C

CE 0-6550 Schleiz: Elliger GmbH
CH 8011 Aschheim-Dornach: Hirschbold KG
CS 8703 Ochsenfurt: Mezger+Schlag GmbH & Co.

D

DC 4000 Düsseldorf-Hafen: Manfred Schließer
DD 4354 Datteln-Ahsen: Hans GmbH
DH 4000 Düsseldorf 11: Wolfgang Hake
DI 7295 Dornstetten-Aach: Hans-Jürgen Girgas
DR 6110 Dieburg: Hans Richter
DS 4600 Dortmund: Schröder
DU 4100 Duisburg 14: Autoelektrik Butt
DV 4600 Dortmund-Bodelschwingh: Klaus Völkmann KG

E

EA 7913 Senden: Atterer Autoelektrik-Elektronik
EC 4690 Herne: Peter Schauer
EE 5120 Herzogenrath-Merkstein: Heinz Herff
EH 8091 Eiselfing: Ernst Hehensteiger
EJ 7517 Eppingen: Otmar Roszbach
EL 0-5900 Eisenach: A. Lewandowski
EM 0-4101 Bennstedt: P. Müller & Söhne
EP 2240 Heide: Peters GmbH & Co.
ER 7930 Ehingen: Vinzenz Radi
ES 5630 Remscheid-Haddenbach: Gerd Schulz
EU 0-2520 Elmenhorst: Autotechnik RE-EL-DI GmbH
EW 4300 Essen-Werden: R.-P. Slanik

F

FB 0-5803 Finsterbergen: Edgar Burkhardt
FE 0-8210 Freital: Thomas Reichel
FF 6000 Frankfurt-Rödelheim: Peter Flohr
FM 6000 Frankfurt-Schwanheim: Hans Cohnheim
FR 8550 Forchheim: Ludwig Rattel
FS 8050 Freising: Josef Sittenauer
FT 6364 Friedberg 3-Dorheim: Ludwig Steinbrenner
FW 0-1098 Berlin-Falkenberg: Weichert
FX 6230 Frankfurt-Griesheim: Rauschenberg GmbH

G

GA 7340 Geislingen/Steige: Autoelektrik Staufen GmbH
GD 8192 Geretsried 2: Josef Schmid
GF 8032 Gräfelfing: Friedrich Haberstroh
GG 2341 Gelting: Rolf Kett
GH 0-8245 Glashütte: Lothar Härtel
GK 3170 Gifhorn: Kurt Heinrich
GL 5820 Gevelsberg: Dieter Balzer
GM 8754 Großostheim: Moritz & Morhard GmbH
GP 0-8280 Großenhain: Wolfgang Pietzsch
GS 3400 Göttingen: Wolfgang Streichert
GT 7430 Metzingen: Karl Stiegelbauer
GU 3380 Goslar: Friedrich Wüllner OHG
GV 2054 Geesthacht: Karl Virchow
GY 7928 Giengen/Brenz: Josef Teller

H

HA 2000 Hamburg 60: Hasselbusch & Aretz
HB 5429 Holzhausen: Manfred Bruchhäuser
HC 5840 Herdecke: Diesel-Schneider
HE 0-5630 Heiligenstadt: Volker Riethmüller
HG 4472 Haren/Ems: Tono Gertzen
HH 2000 Hamburg 53: Walter Schramm

H

HI 4700 Hamm: Theodor Wienschulte
HL 2240 Heide/Holst. Karl Wahl
HM 6056 Heusenstamm: Bodo Meier
HP 0-3240 Haldensleben: Wulf Passier
HR 2000 Hamburg 26: Mensing & Pöpp
HS 0-3600 Halberstadt: Autoservice GmbH
HT 2000 Hamburg 76: Manfred Jepsen
HU 2102 Hamburg 93: Kühnel & Becker
HW 5628 Heiligenhaus: Manfred Wevers
HY 2000 Hamburg 11: Rolf Peters
HZ 7450 Hechingen: L & Th. Zimmermann

I

IB 5521 Irrel: Bares GmbH
IF 7174 Ilshofen: Otto Freimüller
IK 3200 Hildesheim: Siegfried Koch
IM 5330 Königswinter-Ittenbach: Curt Müller
IP 5860 Iserlohn-Letmathe: Willi Spill

K

KB 5000 Köln 91: Josef Bliersbach
KC 8429 Kelheim: Karl Friedrich Schmid
KE 5000 Köln 1: Elektro-Pieper GmbH
KH 5000 Köln 50: Hallermayer GmbH
KK 7640 Kehl: Helmut Speck
KL 0-2001 Küssow: Burghard Lück
KO 3540 Korbach: Rudolf Kolb
KP 0-3281 Kleinwusterwitz: Hubert Pilz
KR 0-1532 Kleinmachnow: Korte GmbH
KT 4152 Kempen: Gustav Theurer
KW 8960 Kempten-St. Mang: Thomas Wöhrle
KX 6750 Kaiserslautern: Werner Müller

L

LA 7907 Langenau: Martin Edelmann
LB 0-7961 Luckau-Cahnsdorf: Brüscke Auto-Service
LC 0-7551 Lubolz: Lutz Schloddarick
LF 7257 Ditzingen: Heinz Faber
LG 7850 Lörrach: Grimmeisen & Co. GmbH
LI 7970 Leutkirch: Reinhard Sichler
LJ 4972 Löhne 3: TRW Jankowski GmbH
LM 6840 Lampertheim: Auto-Elektrik Keller
LS 6620 Völklingen 4: Heinrich Ermler GmbH
LT 4710 Lüdinghausen: Jochem Tenderich
LW 7250 Leonberg-Eltingen: Wankmüller GmbH

M

MB 5750 Menden: Hans Bahr
MC 6950 Mosbach: Schweizer + Gatti
ME 4020 Mettmann: Rolf Kardell
MG 7130 Mühlacker: Werner Genthner
ML 7840 Müllheim: Lais - Steffi GmbH
MO 4019 Monheim-Baumberg: Karl Heinz Baur
MR 8052 Moosburg: Walter Greulein
MU 4370 Marl-Sinzen: Thomas van Holt
MX 8302 Mainburg: Karl Manhart

N

NA 2260 Niebüll: Joachim Hansen
NB 8500 Nürnberg: Karl-Heinz Kratzer
NE 8530 Neustadt a.d. Aisch: Heinrich Endlein
NH 5760 Arnsberg 1 (Hüsten): Helmut Schmucker
NK 8500 Nürnberg: Wilhelm Klemm
NM 0-2000 Neubrandenburg: Klaus Mischke
NR 7086 Neresheim: Ernst Rauwolf
NT 4717 Nordkirchen: Rudolf Thygs

O

OK 3360 Osterode-Lasfelde: Rolf Krauel
ON 7596 Achern 2: Bernd Nies
OF 6203 Hochheim/Main: Manfred Petry
OW 5960 Olpe: Heinz Wendt

P

PB 5000 Köln 90 (Porz-Eil): Edmund Breuer
PC 4790 Paderborn: Dr. Ing. Broer GmbH & Co. KG
PH 2080 Pinneberg: W. Hellfritsch & Sohn
PK 0-9900 Plauen: R. Kiesel
PS 8570 Pegnitz: Hälder GmbH

R

RA 0-2320 Grimmen: Auto-Center Grimmen GmbH
RB 7760 Radolfzell: Thomas Brix
RC 3300 Braunschweig: Dr. Schmidt
RD 7888 Rheinfelden: Fritz Niethammer KG
RF 4350 Recklinghausen Süd: Gotthard Fietzek
RG 4050 Mönchengladbach 2: Peter Ramovic
RJ 5000 Köln 1: Heinrich Kirfel
RN 6096 Raunheim: Manfred Neiß
RP 6914 Rauenberg: Karl-Heinz Spannagel
RX 8400 Regensburg: Josef Knorr

S

SA 2160 Stade: Otto und Helmut Krusemark
SC 6670 St. Ingbert: Werner Schmidt GmbH
SD 0-7610 Schwarze Pumpe: Uwe Diering
SE 6453 Seligenstadt: Klein Kfz-Elektrik
SF 0-2044 Stavenhagen: Laas Kfz-Reparaturen- u. Elektrik
SG 0-9430 Schwarzenberg: Elektroanlagenbau + Kfz-Service
SI 0-7817 Schwarzheide: Gabor Kapitany
SK 6540 Simmern: Lothar und Lutz Kühne
SL 8130 Starnberg: Franz Leithold
SM 6600 Saarbrücken 5: Horst Metzinger
SO 7230 Schramberg-Sulgen: Roland Öhler
SP 4400 Münster-Sprakel: K.H. Stegemann
ST 8972 Sonthofen-Rieden: Lutz Tau
SU 0-7561 Schlagsdorf: Karlheinz Schulze
SV 5509 Schillingen: Karl Vogel
SW 6830 Schwetzingen: Heinrich Wyss
SZ 5200 Siegburg: Johann Zimmermann

T

TH 4995 Steawede: W. Holtkamp
TW 7890 Waldshut-Tiengen 2: Jäger & Markwirth GmbH

U

UA 0-9302 Annaberg-Buchholz: Kfz-Elektrik Günter Baldzuhn
UH 7000 Stuttgart 80: Ricardo Henschel
UM 4400 Münster: Kfz-Mannmann
US 8000 München 25: Georg Seibert
UZ 8500 Nürnberg: Böhm & Zenger GmbH

V

VP 4060 Viersen: Paul Felzer

W

WB 5600 Wuppertal-Barmen: Edmund Herhan
WC 0-6519 Wünschendorf-Elster: Bernd Schleicher
WD 5600 Wuppertal-Cronenberg: Frank Keller
WI 3340 Wolfenbüttel: Franz Thiele
WK 5600 Wuppertal 2: Klumpp & Nowaczyk
WN 4355 Waltrop: Heinz Nowak
WO 5241 Wallmenroth: Martin Rosenbauer
WP 3430 Witzhausen: Auto-Elektrik-Vogelei, Inh. Frank Vogelei
WR 6200 Wiesbaden: Peter Röhrig
WS 0-2900 Wittenberge: Hans-Günter Scheuermann
WT 0-2060 Waren: Hans Staerk
WU 0-2400 Wismar: Kuchenbäcker Autotechnik

W

WV 5600 Wuppertal 22 (Langerfeld): Manfred Dee
WX 6649 Weiskirchen: Willi Schmitt

X

XB 8415 Nittenau: Siegmund Bock
XG 8019 Glonn: Gaube & Skrutl
XM 8600 Bamberg: Mezger+Schlag GmbH + Co.
XR 8202 Bad Aibling: Gerhard Graus
XT 2878 Wildeshausen: Werner Tewes
XW 4236 Hamminkeln: Hermann Weyer

Y

YE 5432 Wirges: Elektro- und Dieseldienst
YH 4800 Bielefeld 18: E.G. Wrase
YS 2000 Hamburg 54: Berthold von Sömm
YX 2100 Hamburg 90: Werner Peters

Z

ZI 8440 Straubing-Hofstetten: Franz Bründl
ZZ 3330 Helmstedt: Albrecht Ranft

6. BELGIEN, BELGIUM, BELGIQUE, BELGICA, BELGIO,



A

BAB 1160 BRUXELLES: ATREAC S.P.R.L., CHSSE DE WAVRE, 1261
BAC 1060 BRUXELLES: ATREAC S.P.R.L., CHSEE DE WATERLOO, 540
BAM 2800 MECHELEN: ATREAC P.V.B.A., VAN KESBEECKSTRAAT, 64
BAT 1300 WAVRE: ATREAC S.P.R.L., AV DES PRINCES, 44

B

BBU 6600 BASTOGNE: ETS. BURTON S.P.R.L., ROUTE DE MARCHE, 38

C

BCA 6001 MARCINELLE: S.P.R.L. CADAUTO, AV E MASCAUX, 521
BCE 6001 MARCINELLE: CHARL EROI ELECTRO DIESEL, AV. DE PHILIPPEVILLE, 266
BCD 6400 OOSTENDE: COPPIN A. N.V., TORHOUTSESTEENWEG, 639
BCR 9240 ZELE: GARAGE MARC CARMELIET, GENTSESTEENWEG, 87
BCV 3511 KURINGEN: AUTO ELECTRO CAR-VAN N.V., STEVOORTSEKIEZEL, 10

D

BDB 7300 BOUSSU: ETS FRANZ DUBOIS, ROUTE DE VALENCIENNES, 483
BDD 4800 VERVIERS: S.P.R.L. EMILE DEDERICHS ET FILS, CHSEE DE HEUSY, 46
BDE 4100 SERAING: ETS. DENIS, RUE COLSON, 68
BDG 9112 SINAAI: AUTO ELEC. RENE DE GREYT, FUJVELDESTRAAT, 6
BDR 6460 CHIMAY: ETS. L.DURLET-MIGEOTTE, CHSEE DE TRELON PARC INDUST.
BDU 5000 NAMUR: ELECTRICITE AUTOMOBILE JEAN DUFEYS, BD DU NORD, 30
BDY 8020 OOSTKAMP: DEDEYNE, KORTRIJKSTRAAT, 72

E

BEA 2020 ANTWERPEN: ELCO P.V.B.A., JAN VAN RIJSWIJCKLAAN, 296
BEL 4520 WANZE: ELECTRIC-AUTO S.P.R.L., CHSEE DE TIRLEMONT, 91
BET 2300 TURHOUT: ELCO P.V.B.A. VISBEEKSTRAAT, 3

F

BFI 2500 LIER: J. FIERENS, ANTWERPSESTEENWEG, 382

G

BGA 8790 WAREGEM: GALLE WERNER BVBA, ZULTSEWEG, 154

6. BELGIEN, BELGIUM, BELGIQUE, BELGICA, BELGIO,

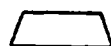

H

BHD 7700 MOUSCRON:ETS. AUTO MEKA, RUE DE ROUBAIX, 199
BHT 4020 JUPILLE: ETS. HRT S.P.R.L., RUE DU COUVENT, 52

I

BID 8740 PITTEM: IDE GEBROEDERS P.V.B.A., BRUGSESTEENWEG, 91
BIG 9710 GENT-ZWIJNAARDE: JDE BVBA, GROTE STEENWEG-NOORD, 5
BIS 1730 KOBEGEM: IDES AFD. VAN HOVE N.V., BREKERLAAN, 43

J

BJA 3680 MAASEIK: FRANS JANSSEN, INDUSTRIETERREIN,

K

BKE 4300 WAREMME: ETS. J-M KEPPEL S.P.R.L., RUE F. BOVESSE, 3

L

BLE 7000 MONS: S.P.R.L. A.LEGRAND, RUE CHISAIRE, 22
BLI 7525 MERSCH: ETS. MARTIN LIEFFRING, RUE DE COLMARBERG, 64

M

BMA 4780 SAINT-VITH: ETS. W. MANDERFELD, VIEILLE ROUTE D'AIX, 7
BME 4840 WELKENRAEDT: ETS. LUCIEN MEESEN S.A., RUE MITOYENNE, 905
BMT 6040 JUMET: NOUVEAUX ETS MATHOT, CH DE BRUXELLES, 356
BMX 4020 LIEGE: ETS. ROGER MACHIROUX, BD FRANKIGNOUL, 6

O

BOR 1800 VILVOORDE: ETS. ORINX S.A. N.V., SCHAARBEEKLEI, 27

P

BPH 1940 LUXEMBOURG: AUTO ACCESSOIRES PEUSCH S.A., ROUTE DE LONGWY, 186
BPR 1500 HALLE: ETN. PARIDAENS B.V.B.A., AUG. DAMAEGHTLAAN, 233
BPY 8900 IEPER: PARMENTIER TECHNICS N.V., INDUSTRIELAAN, 15

6. BELGIEN, BELGIUM, BELGIQUE, BELGICA, BELGIO,



R

BRE 3360 KORBEEK-LO: PIK VAN EYKEN, TIENSESTEENWEG, 169
BRK 3920 LOMMEL: ROOYACKERS AUTO-SERVICE N.V., BALENDIJK, 40
BRD 5100 JAMBES: ETS. J. ROBIN, CH. DE LIEGE, 524

S

BSM 4910 THEUX: ETS. CHARLES SMETS, RUE AUX DIGUES, 53
BSR 1861 WOLVERTEM: SERGOYNE P.B.V.A., VEILINGLAAN, 18
BST 5030 GEMBLoux: ETS. CHRISTIAN SFNTERRE, CH DE CHARLEROI, 110

T

BTE 7500 TOURNAI: ETS. RENE TELLE S.A., RUE MOREL, 22

V

BVA 8770 JNGELMUNSTER: M. VANDENABEELE P.V.B.A., KORTRIJKSTRAAT, 174
BVD 1910 KAMPENHOUT: FRANS VAN DER AUWERAER, OUDESTRAAT, 75
BVG 4000 LIEGE: VALOIR & GATHOYE S.P.R.L., QUAI ST. LEONARD, 12
BVR 2220 HEIST OP DEN BERG: H.VAN ROMPAEY P.V.B.A., INDUSTRIEPARK, 22

W

BWA 9085 ETTTELBRUCK: WAGNER S.A.R.L., ZONE INDUSTRIELLE,

Z

BZI 6740 ETALLE: ETS. ZIMER, RUE LENCLOS, 29

6. SCHWEIZ, SWITZERLAND, SUISSE, SUIZA, SVIZZERA,

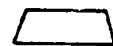

A

CAD 9434 AU: OSKAR DUTLER
CAE 4663 AARBURG: ROLF ERNE
CAH 5000 AARAU: BERNHARD HISCHIER
CAJ 5000 AARAU: W. JÄGGI AG
CAL 8580 AMRISWIL: EMIL LINDENMANN
CAM 1860 AIGLE: ALDO MOMBELLI
CAS 9320 ARBON: ADOLPH SAURER AG
CAW 4123 ALLSCHWIL: W. JÄGGI AG

B

CBA 6828 BALERNA: Autolux
CBB 6500 BELLINZONA: ING. STS CARLO BOSIA
CBC 2503 BIEL: GEBR. TEUTSCHMANN
CBE 6340 BAAR: FERRIER, GÜDEL & CO.
CBI 7402 BONADUZ: HEINZ ITEM
CBK 9470 BUCHS: PAUL KAISER
CBM 3018 BERN: SIM AG
CBN 6710 BIASCA: NOTARI SA
CBO 6340 BAAR: BENI ROGGENMOSER
CBQ 1630 BULLE: RENE DE GOUDRON
CBR 4054 BASEL: E. & R. FRIEDRICH
CBT 8180 BULACH: ALBERT STALDER
CBW 4922 BÜTZBERG: WILLY SCHAWALDER
CBY 3000 BERN: ZYLINDERSCHLEIFWERK
CBZ 3012 BERN: HANS ZAUGG AG

C

CCP 1618 CHATEL-ST.DENIS: JEAN-PAUL FILLOUD
CCR 7000 CHUR: REDOC AG
CCS 7000 CHUR: SCHUMACHER & BURKHARD
CCV 1030 BUSSIGNY: VOLTEC SA
CCW 2300 LA CHAUX DE FONDS: WINKLER SA

D

CDD 7270 DAVOS-PLATZ: DOSCH-CENTRALGARAGE
CDE 8305 DIETLIKON: HANS DALLE CARBONARE
CDU 2800 DELEMONT: DUPLAIN & CIE.

E

CEK 8840 EINSIEDELN: WENDELIN KÄLIN
CEL 6020 EMMENBRÜCKE: LASTWAGEN & BAUMASCHINEN AG
CEM 6274 ESCHENBACH: KURT MÜLLER

6. SCHWEIZ, SWITZERLAND, SUISSE, SUIZA, SVIZZERA,



F

CFH 5262 FRICK: W. HASLER AG
CFI 1701 FRIBOURG: CENTRE P. RIESEN SA
CFR 8500 FRAUENFELD: GAHWILER AUTOELEKTRO

G

CGC 1227 GENEVE: ATELIERS J. SCHMID SA
CGE 1211 GENEVE: CVT SA
CGF 9403 GOLDACH: RENE FÖGER
CGH 9403 GOLDACH: P. HEUBERGER AG
CGK 9202 GOSSAU: E. KLAUS AG
CGM 1205 GENEVE: MILLET SA
CGP 8954 GEROLDSWIL: KARL POZZI
CGS 9014 ST. GALLEN: E. STIEGER AG
CGU 5722 GRANICHEN: F. WÜGLER
CGW 8750 GLARUS: WEBER & CO.

H

CHB 4127 BIRSFELDEN: HUBER & BUSER AG
CHE 9100 HERISAU: ERNY AG
CHH 3615 HEIMENSCHWAND: HANS BEUTLER
CHW 4614 HAGENDORF: ROLAND WYSS

K

CKT 8302 KLOTEN: TRUCK AG

L

CLA 1006 LAUSANNE: J.C. BAUMGARTNER
CLB 6900 LUGANO: ING. STS CARLO BOSIA
CLD 6601 LOCARNO: MICHELE RUSCONI
CLF 6000 LUZERN: FERRIER GÜDEL & CO.
CLH 4242 LAUFEN: H. MÜLLER
CLT 6616 LOSONE: V. MARTINBIANCO

M

CMB 6712 MALVAGLIA-CHIESA: LUCA BLOTTI
CME 6850 MENDRISIO: RODOLFO KEISER
CMG 1920 MARTIGNY: JEAN-PIERRE GUËX
CMH 4313 MÖHLIN: HASLER AUTOELEKTRIK AG
CMI 1870 MONTHÉY: HAROLD MISSILIEZ
CMM 1110 MORGES: MAURON ET FILS
CMZ 8887 MELS: B. BRUNSCHWILER

6. SCHWEIZ, SWITZERLAND, SUISSE, SUIZA, SVIZZERA,

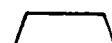

N

CNK 5702 NIEDERLENZ: KERN AG
CNM 2000 NEUCHÂTEL: JEAN-PIERRE MONNEY

O

COA 4600 OLTEN: ERNST ERLACHNER
COB 4600 OLTEN: BLEUEL AUTOELECTRIC
COH 5504 OTHMARSINGEN: HEINRICH HÄCHLER AG

P

CPD 1530 PAYERNE: JEAN-PIERRE DESPLAND

R

CRE 9403 GOLDACH: PAUL HEUBERGER AG
CRF 8105 REGENSDORF: W. FRANK AG
CRG 6023 ROTHENBURG: FERRIER + GÜDEL AG
CRH 8630 RÜTI: HÜRLIMANN & CO. AG
CRS 6260 REIDEN: SCHÜRCH & ZIMMERLI AG
CRT 4444 RÜMLINGEN: GEBR. THOMMEN AG
CRU 8805 RICHTERSWIL: HUGO STECHER AG
CRZ 8723 RUFİ-SCHANIS: ALFONS ZIEGLER

S

CSA 7502 BEVER: WILLI AMSTAD
CSB 6370 STANS: HANS BACHMANN
CSD 7402 SILS-DOMLESCHG: AUTO DECURTINS AG
CSI 3945 STEG-GAMPEL: JOSEF IMBODEN
CSL 4410 LIESTAL: E. SCHÖNENBERGER
CSN 1951 SION: BOVAL SA
CSF 1049 SULLENS: ROGER PAPAUX
CSQ 9494 SCHAAN: HERMANN QUADERER
CSS 8205 SCHAFFHAUSEN: WALTER SCHMID
CSW 4528 ZUCHWIL: AUTO-ELEKTRO AG
CSZ 6210 SURSEE: SCHÜRCH + ZIMMERLI AG

U

CUM 8730 UZNACH: ERNST MÜLLER
CUS 5222 UMIKEN: RUDOLF SCHLATTER
CUW 8610 USTER: KLAUS WAGNER

6. SCHWEIZ, SWITZERLAND, SUISSE, SUIZA, SVIZZERA,



V

CVH 3930 VISP: ROBERT HENZEN
CVP 1800 VEVEY: PITTET & CHABLOZ SA

W

CWA 5430 WETTINGEN: AUTO-ELEKTRO AG
CWB 3812 WILDERSWIL: AUTO BALMER AG
CWH 9630 WATTWIL: E. HEDINGER AG
CWK 5610 WOHLLEN: H.R. KAUFMANN
CWL 9500 WIL: LARAG AG
CWN 8400 WINTERTHUR: NYFEGA AG
CWT 8633 WOLFHAUSEN: STERKI AG
CWU 9500 WIL: BRUGGMANN & CO.
CWW 8433 WEIACH: ALBERT WEIBEL

Y

CYB 1400 YVERDON: JOSEPH BURATTI

Z

CZD 8036 ZÜRICH: DEZAG
CZG 8045 ZÜRICH: TH. GIGER AG
CZT 8037 ZÜRICH: TAXAG AG

5. DANEMARK, DENMARK, DANEMARK, DINAMARCA, DANIMARCA,

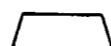

A

DAB 6700 ESBJERG: BRDR. H. CHRISTIANSEN'S ETFT., EXNERGADE 12 - 18
DAC 7400 HERNING: HE SERVICE CENTER, GUDHJEMVEJ 3
DAD 3400 HILLEROD: JUNKER APS, VOLUNDSVEJ 5
DAE 8900 RANDERS: RANDERS ELEKTRO SERVICE I/S, ERIKSVEJ 11
DAF 7000 FREDERICIA: FREDERICIA AUTOGUMMI & BATTERILAGER, FR. HANSENS ALLE 27-29
DAG 7200 GRINDSTED: A/S E. JOHANSENS MOTORSERVICE OG AUTOELEKTRO, ODINSVEJ 9
DAH 2640 HEDEHUSENE: KAMDIESEL, AKACIEVEJ 16, FLONG
DAI 6950 RINGKOBING: RINGKOBING AUTO-ELEKTRO, HERNINGVEJ 78-80
DAJ 9800 HJORRING: AUTOTEK-NORD A/S, FREDERIKSHAVNSVEJ 31
DAK 6000 KOLDING: SYDJYDSK DIESEL ELEKTRO APS, JERNET 15
DAL 4300 HOLBAEK: AUTO-EL.CENTRET, SPANNEBAEK 6
DAM 7500 HOLSTEBRO: H.V. ELEKTRO, GARTNERIVEJ 17
DAO 5230 ODENSE M: LANGE JORGENSENS EFTF., TAGTAEKKERVEJ 4
DAP 4400 KALUNDBORG: JAN GLAD AUTOELEKTRO, SLAGELSEVEJ 77
DAR 4100 RINGSTED: R.V.T SALGS OG SERVICE CENTER A/S, THORSVEJ 12
DAT 2720 VANLOSE: TEGNER HANSEN APS, SKJULHOJ ALLE 35
DAU 2860 SOBORG: SOBORG AUTO ELEKTRO A/S, SOBORG HOVEDGADE 1
DAV 2600 GLOSTRUP: GLOSTRUP AUTO-ELEKTRO, FABRIKSPARKEN 41
DAW 4700 NÆSTVED: NÆSTVED AUTO-ELEKTRO APS, ADERUPVEJ 7-9
DAX 8500 GRENA: GRENA AUTO-EL., FABRIKVEJ 12
DAY 8600 SILKEBORG: SIIM BIL-ELEKTRO, NAVERVEJ 21
DAZ 7800 SKIVE: ALBERS ELEKTRO APS, H.C. ORSTEDSVEJ 24

B

DBA 6900 SKJERN: SKJERN ELEKTRO APS, VARDEVEJ 34
DBB 2750 BALLERUP: ROBERT BOSCH A/S, TELEGRAFVEJ 1
DBC 4200 SLAGELSE: SLAGELSE AUTO ELEKTRO APS, SOROVEJ 3
DBD 7600 STRUER: STRUER ELEKTRO, FABRIKSVEJ 26
DBE 5700 SVENDBORG: ELEKTRO, GRONNEMOSEVEJ 8
DBF 7100 VEJLE: VEJLE BIL ELEKTRO APS, DIANA VEJ 3
DBG 8240 RISSKOV: BG SERVICE CENTER, GRENAVEJ 148
DBI 8800 VIBORG: I/S VIBORG AUTO-ELEKTRO, ABSALONSVEJ 3
DBJ 9300 SÆBY: AUTOTEKNIK A/S, ALBORGVEJ 77
DBK 4600 KOGE: MAGNETO KOGE, ORNEVEJ 1-3
DBL 9100 ALBORG: NORDJYSK DIESEL ELEKTRO APS, HJULMAGERVEJ 38
DBM 2100 KOBENHAVN O: MAGNETO, AEBELOGADE 18
DBN 4800 NYKOBING F: NYKOBING F ELEKTRO-DIESEL APS, ARHUSVEJ 22
DBO 3900 GODTHAB/GRONLAND: GODTHAB ELEKTROVAERKSTED, POSTBOX 70
DBP FR-410 KOLLAFJORDUR/FAEROERNE: KDT ELEKTRO
DBR 2730 HERLEV: RUDERS DIESEL APS, TVAERDIGET 19
DBT 6270 TONDER: BDR. WALZ DIESEL ELEKTRO I/S, FABRIKSVEJ 19
DBU 3000 HELSINGOR: DIESEL ELEKTRO HELSINGOR/APS, OLE ROMERSVEJ 21
DBW 9200 ALBORG SV: P. WARMINGS EFTF., FREDERIKSTADVEJ 5
DBX 3700 RONNE: AUTOGARDEN RONNE APS, INDUSTRIVEJ 14
DBY 4100 RINGSTED: GEORG NIELSEN DIESEL SERVICE A/S, ROSKILDEVEJ 194

6. DANEMARK, DENMARK, DANEMARK, DINAMARCA, DANIMARCA,



C

DCA 2300 KOBENHAVN S: AMAGERMOLLER, KRIMSVEJ 21
DCB 4200 SLAGELSE: VESTSJAELLANDS DIESEL CENTER APS, KALUNDBORGVEJ 65
DCC 7700 THISTED: THISTED DIESEL ELEKTRO APS, THORSTEDVEJ 80

6. SPANIEN, SPAIN, ESPAGNE, ESPANA, SPAGNA,

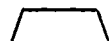

A

EAB ALBACETE: DAVASA
EAC ALICANTE: DAVASA
EAD ALMERIA: DAVASA
EAE OVIEDO: ELECTRODIESEL ASTURIAS
EAF PALMA DE MALLORCA: DAVASA
EAG BARCELONA: COMMERCIAL ERICH RIST
EAH MANRESA: AUTO REPARACIONES VEVI, S.L.
EAI BURGOS: PALACIOS MOTOR, S.A.
EAJ JEREZ DE LA FRONTERA: COPASA
EAK SANTANDER: CASTELLANOS DE SANTANDER
EAL CASTELLON: EDECO
EAM CIUDAD REAL: GARCIA GALA, S.A.
EAN CORDOBA: DISSUR, S.A.
EAO CORUNA, LA: EDELMIRO RODRIGUEZ, S.L.
EAP GERONA: ELECTROMOVIL GERUNDA, S.A.
EAR GRANADA: AHISA
EAS SAN SEBASTIAN: ARIZTI, S.A.
EAT HUELVA: AUTO MAR
EAU HUESCA: EMILIANO ARENAZ, A.S.
EAV JAEN: DAISA
EAW LEON: AUTO INYECCION VIDAL, S.A.
EAX LERIDA: AUTO SUMINISTROS LERIDA
EAY LUGO: EDELMIRO RODRIGUEZ, S.L.
EAZ ZARAGOZA: EMILIANO ARENAZ, S.A.

B

EBA MADRID: PEDRO SANZ, S.A.
EBB MADRID: RADE
EBC MOSTOLES: EDIMO
EBD MALAGA: ACCESORIOS/HERRAMIENTAS
EBE MURCIA: DAVASA
EBF PAMPLONA: TALLERES DIESEL VICTOR
EBG ORENSE: EDELMIRO RODRIGUEZ, S.L.
EBH VIGO: MERCURIO TALLER MECANICO
EBI SALAMANCA: ANTONIO MARTIN GARCIA
EBJ SEVILLA: MOTRISA
EBK SORIA: EMILIANO ARENAZ, S.A.
EBL REUS: COMERCIAL BATET, S.A.
EBM MISLATA: RECIMSA
EBN VALLADOLID: ANTONIO MARTIN GARCIA
EBO BILBAO: TALLERES ARIZTI
EBP VITORIA: TALLERES ARIZTI
EBT TOLEDO: RADE

6. SPANIEN, SPAIN, ESPAGNE, ESPANA, SPAGNA,



C

ECA VITORIA: GARAJE DESAMPARADOS
ECB ALBACETE: PEDRO MORAGA SARRION
ECC VILLAROBLEDO: FRANCISCO MARTINEZ MONTEJANO
ECD ALBACETE: JOAQUIN LOPEZ ALONSO
ECE ALBACETE: JOSE MARTIN PONCE
ECF ALMANSA: TALLERES MEPA
ECG HELLIN: AUTO REPUESTOS GARCIA
ECH ONTUR: TALLERES GOMEZ
ECI RODA, LA: RAMON CUCHILLOS
ECJ VILLAROBLEDO: MANUEL Y ANTONIO PEREZ
ECK BENISA: VICENTE IVARS IVARS
ECL CALPE: MIGUEL GONZALEZ GINER
ECM DEHESA DE CAMPOAMOR: TALLERES QUESADA, SA
ECN DENIA: TALLERES LARA
ECO ELECHE: CAMPILLO Y MARCOS, SL
ECP ALCOY: JOAQUIN FERRANDCO
ECR ALMORADI: ISIDRO RUIZ MACIAS
ECS ALTEA: JOSE LLORENS
ECT CALLOSA DE SEGURA: DANIEL CASES SAEZ
ECU COX: HERMANOS FUENTES
ECV CREVILLENTE: TALLERES FERNANDEZ
ECW ELCHE: JOSE ANTONIO PARRA
ECX ELDA: PEDRO ARCAS JUAN
ECY NOVELDA: FAUSTINO FALCO AMOROS
ECZ MADRID: TALLERES ANGEL SANZ

D

EDA TORREVIEJA: ELECTRO MECANICA HERNANDEZ
EDB EJIDO, EL: ESTEBAN VALDIVIESO
EDC ALBOX: MANUEL OLIVARES SOLA
EDD ALMERIA: GABRIEL RUIZ CAMPOS
EDE ALMERIA: TALLER ELECTRICO VILLEGAS
EDF HUERCAL-OVERA: TOMAS VILAR PARRA
EDG PULPI: ANDRES MUNOZ MIRAS
EDH ROQUETAS DE MAR: TALLERES JUAN MARTIN
EDI AVILA: LONGINOS MARTIN BARROSO
EDJ BADAJOZ: GASPAS HERMANOS
EDK DON BENITO: TALLER PEDROSA
EDL CASTUERA: LUCIO MARTIN MATIAS
EDM FREGENAL DE LA SIERRA: TALLERES ROMERO
EDN BADAJOZ: TALLERES SALAMANCA
EDO VILLANUEVA DE LA SERENA: MACASAS, A. R. M.
EDP ZAFRA: ANGEL SANCHEZ DE MIGUEL
EDR FELANIXT: TALLERES OLIVER
EDS PALMA DE MALLORCA: TALLERES AUTONOVA
EDT CALA RATJADA: TALLERES K. LIESEGANG
EDU PALMA DE MALLORCA: ANTONIO SERRA MAS
EDV PALMA DE MALLORCA: TALLERES BJ
EDW PUEBLA, LA: REISA
EDX ARTES: ELECTRICA TOSCAS
EDY BADALONA: AUTO ELECTRICA MONTGAT

6. SPANIEN, SPAIN, ESPAGNE, ESPANA, SPAGNA,



D

EDZ MADRID: TALLERES ANTONIO

E

EEA BARCELONA: CONTROL CAR
EEB BARCELONA: JOSE SOBREPORA
EEC BARCELONA: SAMASTER, S. A.
EED BARCELONA: SEBASTIAN ALLUE CASTRILLO
EEE BARCELONA: T. MARTI SALLEN
EEF BARCELONA: TALLERES JUGUET, S. L.
EEG BARCELONA: TALLERES J. CRIVILLE
EEH BERGA: ELECTRO AUTO IND. RATES
EEI FRANQUESAS, LAS: ELECTRICIDAD VALENTI
EEJ FRANQUESAS, LAS: TALLERES MASTER
EEK GRANOLLERS: J. TRAVERIA
EEL HOSPITALET DE LLOBREGAT: AUTO ELECTRIC MITJAVILLA
EEM MANRESA: ELECTROMOVIL SANMARTI
EEN MANRESA: JOSE TORRESCASANA
EEO MASNOU: CIA. MOTOR MASNOU
EEP MOLLET DEL VALLES: ELECTRO DIESEL MOLLET
EER PRAT DE LLUSANES: T. AUTO ELECT. J. NOUGUERA
EES RIPOLLET: AUTO ELECTRIC, RIPOLLET
EET RODA DE TER: E. I. JAIME MOLET
EEU SABADELL: J. UROZ
EEV SABADELL: JUAN GARRIGA
EEW SAN BAUDDILLO DE LLOBREGAT: SERV. ELECT. MUNTANE
EEX SAN CELONI: ELECTRO AUTO J. VELA
EEY SAN FELIU DE LLOBREGAT: ELECTRO ESTRADA
EEZ MADRID: TALLERES HERACLIO GOMEZ

F

EFA SAN VICENT DELS HORTS: AUTO ELECTRIC FERNANDEZ
EFB TARRASA: TALLERES COLON
EFC TARRASA: TALLERES MASA
EFD TONA: AUTO ELECTRIC
EFE TORELLO: AUTO ELECTRIC RIFA
EFF VICH: ELECTROMOVIL
EFG VILLANUEVA Y GELTRU: AUTO TALLER J. J.
EFH BARCELONA: ELECTROMOVIL FUSTER HERMANOS
EFI BADALONA: TALLERES J. GUELL
EFJ BARCELONA: AUTO SERVICIO ELECTRICO
EFK BARCELONA: TALLERES COT
EFL BARCELONA: TALLERES MAVE
EFM BARCELONA: VIU-CAR S. A.
EFN CAPELLADES: GARAJE MARGARIT
EFO CARDEDEU: TALLERES AMELA
EFP ESPLUGAS DE LLOBREGAT: T. CLAUDIO SIMON
EFR GARRIGA, LA: ELECTRO FORTUNI
EFS HOSPITALET DE LLOBREGAT: TERMA
EFT LLINARS DEL VALLES: TALLERES JOSE JANE

6. SPANIEN, SPAIN, ESPAGNE, ESPANA, SPAGNA,

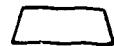

F

EFU MANLLEU-VICH: AUTO ELECT. MIQUEL
 EFV MASQUEFA: AUTO ELECT. J. PEREZ
 EFW MATARO: ELECTRO MECANICA MARESMÀ
 EFX MOLINS DE REY: AUTO MITJAVILLA
 EFY TARRASA: T. ROBERT BERNAT
 EFZ MADRID: TALLERES J. VENTOSA

G

EGA BURGOS: CARMELO Y ARANA
 EGB BURGOS: ELECTRA AUTO
 EGC ARANDA DE DUERO: ELECTRO AUTO 2000
 EGD BRIVIESCA: TALLERES IZQUIERDO
 EGE LERMA: AUTO ELECTRIC
 EGF PLASENCIA: TALLERES VELASCO, S.L.
 EGG CACERES: TALLS. ELECTROMECC. DIAZ
 EGH CORIA: HERMANOS MARTIN
 EGI CACERES: TALLERES JOSE MARY
 EGJ MORALEJA: HERMANOS MARTIN
 EGK TRUJILLO: TALLERES ANFER
 EGL ALGECIRAS: T.E.M. SALVADOR SERRANO
 EGM ARCOS: MANUEL ORDONEZ ALPRESA
 EGN CADIZ: ANTONIO MACIAS LOPEZ
 EGO JEREZ DE LA FRONTERA: ELECTROAUTO
 EGP JEREZ DE LA FRONTERA: TALLERES VIRROME, S.A.
 EGR PUERTO DE SANTA MARIA, EL: PUERTO CAR
 EGS SANLUCAR DE BARRAMEDA: T.E. JOAQUIN GARCIA
 EGT COLINDRES: ELECTROMOVIL
 EGU MURIEDAS: TALLERES GERARDO CABO
 EGV SANTANDER: TALLERES ELECT. BARCENAS
 EGW CARRASCOSA DEL CAMPO: TALLERES PEREZ
 EGX SOLARES: TALLER ELECTRICO SOLARES
 EGY TORRELAVEGA: AUTO ELECT. LUIS GONZALEZ
 EGZ MADRID: TALLERES MIGUEL MORA

H

EHA CAMARGO: ELECTRICIDAD QUINTANA
 EHB SANTANDER: TALLERES NAVAMUEL
 EHC CUENCA: FELIX ROJO SAINZ
 EHD SANTONA: ELECTRO CHISPA
 EHE TORRELAVEGA: TALLERES AUTO ELECTRICOS, S.A.
 EHF BENICARLO: JUAN ANTONIO TARRAGO
 EHG CASTELLON: TALLERES MARTINEZ
 EHH SEGORBE: TALLERES JUVIBAL
 EHI TORREBLANCA: EMILIO CASALS
 EHJ VINARZ: TALLERES CASANOVA
 EHK ALCORA: TALLERES GIAL
 EHL BENASAL: PIBEL
 EHM CASTELLON: AUTO ELECTRICO HNOS. GUAL
 EHN MORELLA: ELADIO PLANELL

6. SPANIEN, SPAIN, ESPAGNE, ESPANA, SPAGNA,

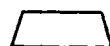

H

EHO NULES: TALLERES PEREZ JORDAN
 EHP VILLAREAL: TALLERES PALOMARES
 EHR PUERTOLLANO: ANTONIO MENSALVAS
 EHS VALDEPENAS: EUGENIO ROLDAN
 EHT FERNAN NUNEZ: TALLERES MIRANDA
 EHU MONTALBAN: ELECT. MARIO CABELLO
 EHV POZO BLANCO: T.E. GUILLERMO MARQUEZ
 EHW PALMA DEL RIO: T. GUADIX-LINAN
 EHX BAYO: MANUEL ESPASANDIN
 EHY CEE: RAMON CANOSA SENRA
 EHZ MADRID: TALLERES PACIOS

I

EIA FERROL, EL: ELECTRO AUTO, S.L.
 EIB MELLID: TALLERES ELECT. ANGEL SANCHEZ
 EIC ORDENES: TALLERES VIDAL
 EID RACHA, LA: ELISEO PENA MIRA
 EIE SANTIAGO DE COMPOSTELA: GONZALO PALMEIRO
 EIF MOTILLA DEL PALANCAR: JUAN JOSE LUCAS CUESTA
 EIG GANDARA, LA: CEN-PAN
 EIH PADRON: TALLERES QUINTELA
 EII SADA: TALLERES VARELA
 EIJ VIONO-INFUESTA: TALLERES REYVA
 EIK CAMPDEVANEL: GARAJE COSTA
 EIL CASSA DE LA SELVA: AUTO ELECTRIC. JORDA
 EIM GERONA: RAFAEL SABORIDO GABRI
 EIN LLAGOSTERA: TALLERES BERNIS, S.A.
 EIO LLORET DE MAR: GARAJE PARK
 EIP ROSAS: ELECTROMOVIL ROSAS
 EIR SALT: ELECTROAUTO GERONA
 EIS SAN FELIU DE GUIXOLS: AUTO ELECTRICA RALLY
 EIT TOSSA DE MAR: GARAJE TOSSA
 EIU ANGES: ELECTROTER
 EIV BESALU: AUTO ELECTRIC, BESALU
 EIW GERONA: TALLERES ROCA
 EIX LLANSA: AUTO ELECTRIC. LLANSA
 EIY OLOT: ELECTROMECCANIA TEIXIDO
 EIZ ALCALA DE HENARES: E. MARTIN, S.A.

J

EJA SAN JUAN DE LAS ABADESAS: ELEC. GUARDIA
 EJB SAN PAU SEGURIES: AUTO ELECTRICO LLUIS
 EJC VERGES: AUTO ELECTRIC. ALBERT
 EJD BAZA: TALLER ELECTRICO VEGAMAR
 EJE GRANADA: AUTO ELECTRIC. SORROCHE
 EJF GRANADA: JESUS HURTADO ABOLLADO
 EJG GRANADA: JUAN GARRIDO ALVAREZ
 EJH GRANADA: TALLERES SANJU
 EJI AZPEITIA: AUTO ELECTRICIDAD JUANTXO

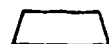

J

EJJ BEASAIN: ELECTRICIDAD ANZIZAR
 EJK IRUN: AUTO ELECT. SAN MARCIA
 EJL LASARTE: ELECT. LASARTE
 EJM MONDRAGON: AUTO ELECT. SAN ANDRES
 EJN SAN SEBASTIAN: TALLERES STOP
 EJO TOLOSA: AUTO-ELEC. ANGEL ONDARZABAL
 EJP HERNANL: T. GARCIA SARASOLA
 EJR OLABERRIA: AUTO ELECT. ILLARQUI
 EJS OYARZU: TALLERES BERE ARGUL
 EJT SAN SEBASTIAN: GAS OLLO, S.L.
 EJU VERGARA: AUTO ELECT. SALZABAL
 EJV VILLABONA: TALLERES ILLUJA
 EJW ZUMARRAGA: AUTO ELECT. SAN JOSE
 EJX ALMONTE: FRANCISCO ESPINA
 EJY ARANCENA: TALLERES ISIDRO JOSE
 EJZ ALCORCON: AUTO ELECTRICO CECILIO

K

EKA AYAMONTE: ELECTRICIDAD VILLEGAS
 EKB HUELVA: ELECTRO MOVIL
 EKC LA PALMA DEL CONDADO: ELECTRO MOVIL
 EKD LEPE: TALLERES ALEJANDRO FLORES
 EKE HUELVA: AUTO ELECTRICIDAD JUAN GARCIA
 EKF HUELVA: T. ELECTRICO FLORES
 EKG VALVERDE DEL CAMINO: MODESTO DE MORA CASTILLA
 EKH BARBASTRO: ELECTRO TALLER DIESEL
 EKI BINEFAR: TALLERES ESTEVE
 EKJ GRANEN: ARGALA, S.A.
 EKK HUESCA: AMADEO ORDUNA, S.A.
 EKL HUESCA: AURELIO MALO ARILLA
 EKM HUESCA: TALLERES ANTONIO LLES
 EKN MONZON: GARAJE ESPANOL
 EKO PENALBA: ELEC. AUTO JOSE PERALTA
 EKP SABINANIGO: ELECTRICIDAD CALVO
 EKR SARINENA: ELECTRICIDAD BORRUEL
 EKS MONZON RIO CINTA: ELECT. AUTOMOVIL RAMON MURILLO
 EKT PEAL DE BECERRO: MANUEL RODRIGUEZ
 EKU PORCUNA: A. NAVAS ORTEGA
 EKV TORRE DONJIMENO: A. FARRAGAS VALENZUELA
 EKW VILLANUEVA DEL ARZOBISPO: T. MORENO FUENTES
 EKX ASTORGA: TALLERES ELECTRICOS PRIGAR
 EKY LEON: CAYETANO F. BERMEJO
 EKZ ALCORCON: TALLERES PALACIOS

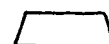

L

ELA FUENTE DE ORBIGO: TALLER ELECTRICO BLANCO
 ELB SANTA MARIA DEL PARAMO: TALLERES MEGAR
 ELC BEMBIBRE: TLL. ELECT. PABLO DE PRADO
 ELD CISTIerna: TALLERES ELECTRICOS HELAS
 ELE BALAGUER: CORELLA SANCHEZ
 ELF BORJAS BLANCAS: TALLERES PRIM
 ELG LERIDA: JOSE ARBONES ARESTE
 ELH SEO DE URGEL: AUTO ELECT. RUBIO
 ELI TARREGA: SERVICIO ELECTRICO SEMAT
 ELJ GOLMES: TALLERES SOL
 ELK LERIDA: TALLERES LERIDA
 ELL LERIDA: TEDASA
 ELM CHANTADA: ROBERTO SANCHEZ SANCHEZ
 ELN LUGO: TALLER ELECTRICO PREIRA
 ELO MONTERROSO: TALLERES SAN CRISTOBAL
 ELF VILLALBA: A. FERNANDEZ VALDESUSO
 ELR VIVERO: TALLERES PEANSU
 ELS FOZ: TALLERES NUNEZ
 ELT MONDONEDO: COOP. MECANICA MINDONIENSE
 ELU MONFORTE DE LEMOS: TALLERES ARGIMIRO
 ELV ALCOBENDAS: GREGORIO GARCIA GOMEZ
 ELW MADRID: LUIS NAVARRO CORRAL
 ELX MADRID: MOLISAN
 ELY MADRID: SANTIAGO HURTADO VERA
 ELZ FUENLABRADA: REPUESTOS REYES

M

EMA SAN SEBASTIAN DE LOS REYES: TALLERES GUIMAR, S.A.
 EMB AVILES: ELECTRO JUANJO
 EMC AVILES: TALLERES MADAFE
 EMD CANGAS DE NARCEA: TALLER ELEC. PEREZ ALVITE
 EME FELGUERA, LA: TALLER GOBERNA, SA
 EMF GIJON: T.E.M. XII ESTRELLAS
 EMG GIJON: TALLERES ALMANFER, SA
 EMH INFIESTO: GARAJE SANCHEZ
 EMI PRAVIA: TALLER ELECTRICO JUANJO
 EMJ GIJON: TALLERES ALONSO
 EMK VILLAVICIOSA: ALFONSO MARTINEZ CRESPO
 EML TARANCON: AUTO CHISPA
 EMM FUENGIROLA: TALLERES IVAN VICHES
 EMN MALAGA: TALLERES CHIPER
 EMO RONDA: TALLERES GUERERO
 EMP ARCHIDONA: TALLERES RAMIREZ
 EMR MALAGA: TALLERES MORENO
 EMS NERJA: AUTOS LORENT
 EMT SIERRA DE YEGUAS: TALLERES ELECTRO ALBA
 EMU TORREMOLINOS: TALLERES LEO
 EMV TORREMOLINOS: TALLERES TURBOSPORT
 EMW CABEZO DE TORRES: ILLS. ENRIQUE BIRRUEZO
 EMX CARTAGENA: SANCHEZ Y MARTINEZ
 EMY DOLORES, LOS: LEANDRO CERVANTES

6. SPANIEN, SPAIN, ESPAGNE, ESPAÑA, SPAGNA,



M

EMZ LORCA: MIGUEL LAZARO DIAZ

N

ENA LORCA: TALLER ELECTRICO MAGO
ENB TOTANA: JOSE REQUENA SANCHEZ
ENC CARAVACA DE LA CRUZ: JOSE ALARTE MORENO
END CARAVACA DE LA CRUZ: MIGUEL TEXTIAS
ENE CARTAGENA: GARRE Y DIEGO
ENF CIEZA: TOMAS OLIVARES GARCIA
ENG FUENTE ALAMO: JUAN ESPARZA NIETO
ENH MOLINA DE SEGURA: JOSE CANO RODRIGUEZ
ENI PALMAR, EL: MANUEL ORENES PINO
ENJ TORREPACHECO: ISIDRO GOMEZ MORENO
ENK TORRES DE COTILLAS: J. NAVARRO BALLESTA
ENL YECLA: TALLERES SORIANO
ENM TUDELA: TALLERES ANGEL
ENN ESTELLA: LIZARRA AUTOMOCION, S.L.
END PAMPLONA: LUS Y ROSAIN, S.L.
ENP NOAIN: TALLERES ANFE
ENR SAN ADRIAN: TALLERES ELECTRICOS RUIZ
ENS CARBALLINO: JOCOMA
ENT CELANOVA: AUTO ELECTRICO
ENU GUDINA, LA: CESAREO RODRIGUEZ
ENV ORENSE: ELECTROKARS
ENW ORENSE: MOSQUERA Y PUMAR
ENX ORENSE: ELECTRICIDAD AUTO
ENY RUA PETIN: TALLERES ANHERDI
ENZ ORENSE: TALLERES BLANCO GOMEZ

O

EOA RIBADAVIA: TALL. ELEC. MEC. PADRON
EOB VERIN: ELECTRICIDAD IGLESIAS
EOC XINZO DE LIMIA: SERGIO PEREZ LORENZO
EOD PALENCIA: TALLERES SANTOS
EOE ESTRADA, LA: AUTO ELECTRICIDAD PAZ
EOF PORRINO: INSTALAUTO
EOG VIGO: HERFER
EOH VILLAGARCIA DE AROSA: PABLO FERNANDEZ GARCIA
EOI CANIZA, LA: AUTO JUAN
EOJ VIGO: GARAJE AQUILINO
EOK VIGO: TALLERES MONFER
EOL LOGRONO: TALLERES PABLO FERNANDEZ, S.L.
EOM HARO: TALLERES JUPER
EON NAJERA: TALLERES NALDA
EOO STO. DOMINGO DE LA CALZADA: TALLERES JULIO RUIZ
EOP CIUDAD RODRIGO: ELECTRICIDAD CURTO
EOR FUENTES DE ONORO: GARAJE CARRALHO
EOS SALAMANCA: ELECTR. ANGEL CABALLERO
EOT VITIGUDINO: JESUS SAN ROMAN

6. SPANIEN, SPAIN, ESPAGNE, ESPAÑA, SPAGNA,

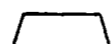

O

EOU CANTALAPIEDRA: PARMENIO MACIAS GARCIA
EOV GUJUELO: VICENTE MARTIN JORGE
EOW PENARANDA DE BRACAMONTE: MATIAS ALVAREZ ALVAREZ
EOX SALAMANCA: BRIZ
EOY SALAMANCA: TURIS MOTOR
EOZ SEGOVIA: MARIANO LOPEZ PINUELA

P

EPA ALCALA DE GUADAIRA: AUTO ELECTRICA FERGA
EPB ECIJA: ELEC. JUAN DIEZ
EPC OSUNA: FRANCISCO FLORES RAMOS
EPD RÓDA DE ANDALUCIA, LA: TALLERES QUINTANA
EPE SEVILLA: ELECTR. AUTO TORREBLANCA
EPF ARAHAL: ROMO ELECTRICIDAD
EPG DOS HERMANAS: FCO. JIMENEZ LOPEZ
EPH LORA DEL RIO: ANTONIO GARCIA MONCLOVA
EPI MORON DE LA FRONTERA: J. MARIA BARRERA VAZQUEZ
EPJ SEVILLA: TALLERES MERCEDES
EPK SAN ESTEBAN DE GORMAZ: ANDRES MANZANARES
EPL SANTA MARIA DE HUERTA: PASCUAL BAILON
EPM SORIA: ROMERA Y SORIA
EPN REUS: TALLERES POBLET
EPO TARRAGONA: ELECTRICIDAD SMITH
EPP TARRAGONA: TALLERES BERNAUS
EPR MONTBLANC: ELEC. DEL A. R. CABESTANY
EPS CALAMOCHA: HERMANOS RODILLA
EPT TERUEL: JOSE PSATOR VILLARROYA
EPU ALCANIZ: TALLERES VIAN
EPV ANOVER DE TAJO: TALLERES ELECTROUNION
EPW MADRIDEJOS: MANUEL RODRIGUEZ DUENAS
EPX QUINTANAR DE LA ORDEN: TALLERES AGUILAR
EPY TALAVERA DE LA REINA: TLLS. ELEC-MEC. LORENZO
EPZ TALAVERA DE LA REINA: FCO. GONZALEZ PAREDES

R

ERA FUEBLA DE MONTALBAN: PEDRO MORON
ERB TALAVERA DE LA REINA: HERMANOS SANCHEZ
ERC TALAVERA DE LA REINA: T. UNION ELECTROMECHANICA
ERD TOLEDO: DIONISIO LOPEZ
ERE ALBAL: TALLERES FRANCES HERMANOS
ERF ALCIRA: ENRIQUE APARIST ESTEVE
ERG ALFAFAR: MANUEL GIMENO
ERH BENETUSER: ELECTROMOVIL CASAN
ERI GANDIA: ROMAGUERA, S.L.
ERJ LIRIA: FRANCISCO CASTILLO VINAIXA
ERK MANISES: TALLERES DIMAS
ERL ONTENIENTE: VICENTE BENEYTO SANZ
ERM TABERNES DE VALLOIGNA: VICENTE ESPI CUCARELLA
ERN VALENCIA: ELECTRO AUTO

6. SPANIEN, SPAIN, ESPAGNE, ESPANA, SPAGNA,



R

ERO VALENCIA: ELECTRO MOVIL, S.C.L.
 ERP VALENCIA: TALLERES NAZARET
 ERR VALENCIA: TALLERES VALMAR
 ERS VALENCIA: TALLERES VIAN
 ERT VALENCIA: FRANCISCO BARRACHINA
 ERU ENGUERA: JOSE MANUEL GOMEZ
 ERV GANDIA: TALLERES MONTAUTO
 ERW MASAMAGRELL: JOSE FERRER TORRES
 ERX MISLATA: FRANCISCO SAFENA
 ERY OLIVA: TALLERES DOMINQUEZ
 ERZ PICASENT: TALLERES VICENTE

S

ESA SOLIANA: VICENTE MONTSERRAT
 ESB VALENCIA: AUTO ELECTRICA FERNANDEZ
 ESC VALENCIA: MOTO-STAR
 ESD VALENCIA: TALLERES ECTAVIO
 ESE VILLANUEVA DE CASTELLON: TALLERES J.FERRANDO
 ESF VILLAR DEL ARZOBISPO: J.M.MOLINA BABILON
 ESG MEDINA DEL CAMPO: ELECT.DIONISIO MENA
 ESH TORDESILLAS: ELECT.DAVID GONZALEZ
 ESI VALLADOLID: MARTINEZ SAN MIGUEL
 ESJ VALLADOLID: CARBURAUTO
 ESK VALLADOLID: GOMEZ DEL HIERRO
 ESL VALLADOLID: TALLERES ALFER
 ESM BILBAO: ANGEL Y VERGARA
 ESN BILBAO: TALLERES LEGUINA, S.A.
 ESO CARRANZA: T.SAN IGNACIO
 ESP DURANGO: REP.ELEC.YURRETA
 ESR AMOREBIETA: AUTO ELEC.ZURE ETXEA
 ESS BARACALDO: TALLERES GOMPAL
 EST DERIO: TALLERES TORRE
 ESU DEUSTO: T.ELECT-MEC.GARIN
 ESV LEMONA: TALLERES SURIA
 ESW TORO: VDA. DE JULIO SANCHEZ
 ESX ZAMORA: GREGORIO ALISTE LAFERAL
 ESY BENAVENTE: ELECTRICIDAD GOYO
 ESZ ZAMORA: GENARO SANCHEZ RODRIGUEZ

T

ETA ATECA: TALLERES ESTEBAN
 ETB CALATAYUD: ANTONIO MOROS MORENO
 ETC EJECA DE LOS CABELLEROS: RAMON LOPEZ JOANIN
 ETD EJECA DE LOS CABALLEROS: T.SANTIAGO RIVED MURC
 ETE FUENTES DEL EBRO: TALLERES PRADES
 ETF LA ALMUNIA DE DONA GODINA: A.ELEC.MONTEAGUDO AZNAR
 ETG MEQUINENZA: AUTO ELEC. ILLANA
 ETH TARAZONA: TALLERS JOSE SANCHEZ
 ETI TAUSTE: ROGELIO GAJATE

6. SPANIEN, SPAIN, ESPAGNE, ESPANA, SPAGNA,

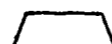

T

ETJ ZARAGOZA: AUTRONIC
 ETK ZARAGOZA: TALLERES ESGAR
 ETL ZARAGOZA: TALLERES JADRAQUE
 ETM ZARAGOZA: TLLS.FRANCISCO POZO
 ETN TAUSTE: T.ELEC.MEC.MARCO ANTONIO
 ETO ZARAGOZA: TALLERES ELECTROAUTO
 ETZ ALCALA DE HENARES: E.MARTIN, S.A.

V

EVA VITORIA: GARAJE IPINA
 EVB ALICANTE: AUTO ALICANTE, S.A.
 EVC ALICANTE: DIESEL ALICANTE
 EVD LUARCA: TALLERES HIGINIO GARCIA
 EVE MANACOR: BERNARDINO BORDOY
 EVF PALMA DE MALLORCA: TALLERES MOREY
 EVG BARCELONA: JUAN ALSINA DEU
 EVH IGUALADA: TURBO DIESEL, S.A.
 EVI SANTA MARIA DE BARBERA: DIESEL LAUSIN
 EVJ GRANOLLERS: GARAJE BAULENAS, S.L.
 EVK BARCELONA: TALLERES YESTE
 EVL BLANES: AUTO DIESEL
 EVM PUIRCERDA: RAMON BOMBARDO BERTRAN
 EVN SAN SEBASTIAN: TALLERES L.M.SARASUA
 EVO DEVA: AUTO REP.DEVA, S.A.
 EVP BAILEN: GABRIEL MALDONADO ARISTA
 EVR LINARES: GABRIEL MALDONADO ARISTA
 EVS PONFERRADA: TALLERES SAYGAL
 EVT GETAFO: MECANO DIESEL CAMPANA
 EVU MADRID: TALLERES V.MATESANZ
 EVV MADRID: SOLEBOL
 EVW MADRID: TLLS. AUTOCARES ESTEBAN RIBAS
 EVX MOSTOLES: TAILS, Y REC.PEREZ HERNANDEZ
 EVY MALAGA: JOAQUIN PEREZ MUNOZ
 EVZ ESPINARDO: JOSE FERNANDEZ MORENO

W

EWA PALMA, LA: TALL.ELECTRICO DIESEL HERCAM
 EWB ALSAVA: SALEGUI HERMANOS
 EWC ORENSE: TALLERES FERNANDEZ BOAN
 EWD SOTOBLANCO: SOTASA
 EWE PONTEVEDRA: SERAFIN QUINTERO
 EWF VIGO: TALLERES GONYMAR
 EWG SEVILLA: LA TECNICA DIESEL
 EWH SORIA: SEBASTIAN IZDO.LOPEZ
 EWJ AMPOSTA: SERVICIO DIESEL EIXARCH
 EWJ VILLASECA: HOLDINGCAR, S.A.
 EWK TALAVERA DE LA REINA: TALLERES FERSAN
 EWL CUART DE POBLET: TALLERES BAYSIA
 EWM PUEBLA DE VALLBONA: INYECCION DIESEL GIMAR

6. SPANIEN, SPAIN, ESPAGNE, ESPANA, SPAGNA,

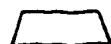

W

EWN SAGUNTO: SERVICIO TECNICO DIESEL
EWO VALENCIA: GOTZ TURBO DIESEL
EWP VALENCIA: AUTO CATALA, S.A.
EWR VALLADOLID: TALLERES HUMASA
EWS AMOREBIETA: TALLERES DIESEL MONTORRA
EWT LEIPA: TALLERES IKEA, S.A.
EWU ZARAGOZA: AGREDA DEL AUTOMOVIL, S.A.
EWV ZARAGOZA: AUTO ELEC. DIESEL MATEO

X

EXL VILLENA: ANTONIO FRANCES SAN JUAN
EXM ADRA: ELECTRICIDAD FERVAZ
EXN IBIZA: AUTO ELECTRIC ROAN
EXO LLUCHMAYOR: AUTO ELECT. BARCELONA
EXP PALMA DE MALLORCA: BARTOLOME MAS MARTI
EXR IGUALADA: FERMIN VALLS
EXS VILLAFRANCA DEL PANADES: ELECTROMOVIL MUNTANER
EXT MIRANDA DEL EBRO: SIMIN. IND. SORIANO
EXU VILLAMARTIN: RUBEN ELECTRICIDAD
EXV ARBUCIAS: TALL. MECA. JORGE AYMERICH
EXW BANOLAS: AUTO ELECTRICIDAD BANOLAS
EXX BISBAL, LA: AUTO ELECTRICIDAD VILA
EXY FIGUERAS: ANGEL ROMANS MARSAL
EXZ OLOT: AUTO ELECTRIC, JAISA

Y

EYA PALAFRUGEL: TALLER ELECTRICO TERUEL
EYB PALAMOS: TALLER ELECTRICO P. LIMERES
EYC TORROELLA DE MONTGRI: ANGEL VALENTI
EYD LOJA: ELECTRO RAMOS QUIROSA
EYE UBEDA: TALLERES ROBLES
EYF PONFERRADA: PARDO RODRIGUEZ HERMANOS
EYG LUGO: TALLER ELECTRICO ALBATROS
EYH ALHAMA: PEDRO JAGAN MARTINEZ
EYX MARTOS: TALLERES HNOS. MEDINA

Z

EZA ALBACETE: SERV. DIESEL J. TOBARRA
EZB ALBACETE: TALLERES GUINTANILLA
EYC RODA, LA: JOSE FELIPE ORTIZ
EZD VILLAROBLEDO: FRANCISCO MARTINEZ JORDAN
EZE ALMANSA: LUIS ALEGRE NAVALON
EZF ALCOY: TECNODIESEL
EZG AGUADULCE: TALLERES SAN ANTONIO
EZH AVILES: A. INYECTOR AVILESINA, SL
EZI GIJON: AUTO DIESEL LINO
EZJ GIJON: TALLERES MODIESEL

6. SPANIEN, SPAIN, ESPAGNE, ESPANA, SPAGNA,



Z

EZK OVIEDO: INYECTO ASTUR
EZL ABONO CARRENO: SOC. COOP. REP. AUTOMOVILES
EZM AVILES: TALLER TECNICO MOTORDIESEL
EZN SALAS: TALLER VILLAR
EZO MIERES: GARAJE TUNON
EZP AVILA: HIJOS DE VICTOR ALCON SRC
EZR AVILA: RECTIFICADOS CRUZ
EZS BADAJOZ: TALLERES FARRA
EZT VILLANUEVA DE LA SERENA: TALLERES FARRA
EZU DON BENITO: TAGASA
EZV IBIZA: AUTO RECAMBIOS ISLA, S.A.
EZW BARCELONA: SERVIDIESEL
EZX BARCELONA: TALLERES DIESEL-BARCINO
EZY GRANOLLERS: DIESEL GRANOLLERS
EZZ HOSPITALET DE LLOBREGAT: TRIDIESEL, S.A.



A

GAA DENHAM: ROBERT BOSCH LTD.
GAB PERTH: J. CALDERWOOD LTD.
GAC GLASGOW: HIGGS LTD.
GAF CARLISLE: RICKERBY LTD
GAG LEEDS 9: ANDREW PAGE LTD.
GAH GOLBOURNE: R.S. DIESEL LTD.
GAJ SHEFFIELD: A.D.E.S.
GAN WALSALL: ELECTRO DIESEL CO.
GAT SWANSEA: SHORTS AUTO ELECTRICAL SERVICES LTD.
GAU WORCESTER: MOBILE ELECTRICS LTD.
GAW BIRMINGHAM: BEAVER AUTO ELECTRIC

B

GBB WATFORD: RUSSELLS AUTO ELECTRIC CO.
GBD LONDON W 4: SPEKTRUM AUTOMOTIVE DISTRIBUTION LTD.
GBF LONDON E 4: CONNAUGHT ELECTRICAL SERVICES
GBG ROMFORD: G.P. AUTO ELECTRIC
GBI TAUNTON: T.A.E. LTD.
GBK GUILDFORD: SURREY AUTOMOTIVE SPECIALISTS
GBM NORWICH: EURODIESEL LTD.
GBN BELFAST: ROBERTSON LTD.
GBO ARMAGH: F.SHERRY LTD.
GBR WEST BROMWICH: BROWNS
GBT DERBY: M.G. AUTO ELECTRICS
GBU ABERDEEN: CHARLES TAYLOR
GBV EASTLEIGH: M&B FUEL INJECTION SERVICES
GBW BARNSLEY: CAMERON MOTOR SERVICE

C

GCB BOSTON: LONGDENS
GCC HOVE: AUTOMARINE DIESEL SERVICE
GCF BURY ST. EDMUNDS: SPECIALIST ELECTRO DIESEL LTD.
GCJ COLDSTREAM: J. RUTHERFORD & SONS LTD.
GCM CROYDON: AUTRICITY LTD.
GCN DRIFFIELD: AUTO ELECTRIC & DIESEL CENTRE
GCP GLASGOW: TURNER & CO. LTD.
GCU HALIFAX: FEATHER DIESEL SERVICES LTD.
GCX AYLESBURY: DIESEL INJECTION SERVICE
GCY KENDAL: ANDREW BROWN LTD.

D

GDA LEEDS 11: SEWELL OF LEEDS
GDE LONDON E17: E.R.E.S. LTD.
GDF LONDON SE 16: TOWER BRIDGE DIESELS
GDG LONDON SW 2: BREN TYLER (ELECTRICAL) LTD.
GDH LONDON SW19: WATSON DIESEL LTD.
GDI MAIDSTONE: HAYNES BROTHERS

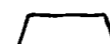

D

GDJ MALTON: ELECTRO DIESEL
GDM NORTHAMPTON: NORTH WEST DIESEL & ELECTRICAL
GDN NOTTINGHAM: FRANK CALDWELL
GDT ST. ALBANS: RUSSELLS AUTO ELECTRIC CO.
GDU SHREWSBURY: K.T.M. SERVICE
GDW SOUTHAMPTON: WORTHY FUELS
GDY SOUTHEND: S.A.M.E.S.
GDZ STIRLING: MICHAEL HARVEY & CO.

E

GEA STOKE ON TRENT: SMITHSON AUTO SUPPLY LTD.
GED WREXHAM: D CROFTS
GEE YEADON: PRECISION DIESEL UNITS
GEG BERWICK: AUTO INJECTION LTD.
GEI ABERDEEN: TURNER DIESEL LTD.
GEJ SALISBURY: HAE FUEL INJECTION
GEM HAVERFORDWEST: AUTO ELECTRICAL & ALLIED SERVICES
GEN AVONMOUTH: K & D AUTO-ELECTRICAL SERVICE
GER LUTON: AUTO TECHNIQUE
GEW INVERNESS: AUTO & GENERAL SERVICES
GEX HODDESDON: WADE DIESELS LTD.
GEZ PRESTON: LEYLAND AUTO ELECTRICAL & DIESEL LTD.

F

GFA LISNASKEA: M. TIERNEY AUTO ELECTRICS
GFB SCUNTHORPE: PETER SLATER FUEL INJECTION ENGINEERS
GFC WELLINGBOROUGH: JOHN HEARN DIESEL SERVICE
GFE LONDON SE 13: LEWISHAM AUTO ELECTRICS
GFG ASHFORD: J.A. THOMAS & SON
GFN CROYDON: FIRST DIESEL INJECTION SERVICE
GFS LEIGHTON BUZZARD: AUTO ELECTRIC SERVICE
GFV MIRFIELD: AUTOMOTIVE ELECTRICAL
GFW RIPON: RIPON AUTO ELECTRICAL
GFX MAGHERAFELT: CRAIGS AUTO ELECTRICAL

G

GGH COLCHESTER: T & M AUTO ELECTRICAL CO.
GGJ KINGS LANGLEY: MACHTECH TUNING
GGL RUNCORN: CARLAIR LTD.
GGN HUDDERSFIELD: R.E. WARD & SON
GGO HULL: HEINZ MOTORS LTD.
GGP HULL: AUTO ELECTRIC SERVICES
GGR PLYMOUTH: CITY AUTO DIESEL LTD.
GGT NOTTINGHAM: F.I.E. LTD.
GGU BALLYMENA: SMITHS ENGINEERING WORKS LTD.
GGV LLANGFNI: AUTO ELECTRIC SERVICE
GGW IRVINSTOWN: ERNE DIESEL SERVICE

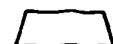

G

GGX BASILDON: F.I.E.S.
GGY ERITH: TURBOCHARGER AUTO ELECTRIC SERVICE

H

GHB LEIGHTON BUZZARD: CHASSIS DEVELOPMENTS LTD.
GHD POYNTON: HOCKLEY GARAGE CO.
GHE MAIDSTONE: CARFORD ELECTRO DIESEL LTD.
GHH CARDIFF: BEARINGS (CARDIFF) LTD.
GHP CANNOCK: CANNOCK AUTO ELECTRICAL
GHT DONCASTER: SURESTART AUTO ELECTRICAL

I

GIB WARWICK: JOHN HEARN DIESEL SERVICE LTD.
GID WINCHESTER: H. A. E. LTD.
GIE MANCHESTER: JOHN LEEFOLD GARAGE
GIG BLYTH: THOMAS FUEL INJECTION SERVICE
GIH STOCKTON ON TEES: T.A. FLAVELL & SONS
GII WARRINGTON: NEWBRIDGE MOTORS
GIM EDINBURGH: LAWSONS DIESELS
GID LOUGHBOROUGH: TETTIX TURBO LTD.
GIF JERSEY: TONY PERCHARD LTD.
GIR WARWICK: WARRINGTONS OF WARWICK
GIW NORTHAMPTON: M.F.I. ELECTRO DIESEL LTD.
GIY NEWBURY: RAYNER ENGINEERING
GIZ CAERNARFON: A.V.W.

J

GJB MANSFIELD: P. ATKINS (F.I.) LTD.
GJC GRIMSBY: LONGDENS
GJD LINCOLN: LONGDENS
GJF MANCHESTER: P.F. JONES DIESEL SERVICE
GJG BEDFORD: ELECTRO DIESEL SERVICE LTD.
GJK GUILDFORD: CHRIS CHANT SERVICES LTD.
GJL SOUTHAMPTON: B.H.B. ENGINEERING LTD.
GJM KIRBYMOORSIDE: C.C. SPECIALIST CARS
GJO KNUTSFORD: EDWARD SMETHURST LTD.
GJP KEIGHLEY: DAVID PEEL
GJS BELFAST: C.J. COLLINS AUTO ELECTRIC
GJU LONDON E.15: UNION AUTOS
GJV COOKSTOWN: D & F AUTO REPAIRS
GJW DOUGLAS: IAN SIMMS AUTO ELECTRIC CO. LTD.
GJX TARPORLEY: DAVID EDGE A.E.S.
GJY OMAGH: MC GOLDRICK BROS.

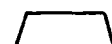

K

GKB CHELMSFORD: SCHILWARD MOTORS LTD.
GKC WELWYN: CHAMBER & GILLIES
GKD DUNSTABLE: AUTOCRAFT LTD.
GKE CHIPPENHAM: CIRCUIT MOTORS
GKF MONTROSE: AUTO ELECTRONICS
GKH FALMOUTH: MILLERS GARAGE
GKK BALLASALLA, I.O.M.: PATRICK CARROLL CARS
GKL NORTHAMPTON: ELITE MOTOR TUNE
GKM TARPORELY: TARPORELY SERVICE CENTRE
GKO READING: R.A. ENGINEERING
GKP CHATHAM: EPPS SPECIALIST CARS
GKS WITNEY: J. MILLIN & SON
GKT LONDON: AUTOCRAFT LTD.
GKU STOCKTON: R. & S. ARMSTRONG
GKV CASTLEFORD: STANLEY STREET GARAGE
GKY MANCHESTER: ATLAS AUTO ELECTRICAL SERVICE

L

GLA LONDONDERRY, N.I.: DERRY AUTO ELECTRICAL
GLC RETFORD: VEHICLE COMPONENT SERVICES
GLD GUERNSEY, C.I.: MARINE & GENERAL ENGINEERS
GLE REDRUTH: RICHARDS BROTHERS
GLF CANTERBURY: AUTO INJECTION & ELECTRICAL
GLH FAREHAM: PANDA FUEL INJECTION AND ELEC. SERVICES
GLI BRISTOL: SHAUN ARKINSTALL
GLJ YEOVIL: ABBEY HILL VEHICLE SERVICES
GLK LEICESTER: WATHES ELECTRO DIESEL
GLL BRISTOL: D.T.M. DIESEL INJECTION SERVICE
GLM COMBERTON: CAMBRIDGE INJECTOR SERVICE
GLN BOSTON: BRIAN GREEN
GLO IPSWICH: FUEL ELECTRICS
GLR LINCOLN: SPECIALIST INJECTOR SERVICE
GLS DUNDEE: DIESEL FUEL SYSTEM SPECIALISTS
GLT ROTHERHAM: YORKSHIRE FUEL INJECTION LTD.
GLV STEWARTSTOWN: MID ULSTER DIESEL SERVICES
GLW BOLTON: NORTH WEST E.D. & FILTER SERVICES
GLX CARTERTON: UNIVERSAL ELECTRO DIESEL SERVICES
GLY BIRMINGHAM: CENTRAL DIESEL INJECTION SERVICE

M

GMA LEICESTER: WATHES ELECTRO DIESEL CO.
GMC ROCHDALE: TECHNOJET
GMD BANBURY: CAR. MOTOR SERVICE
GME TAMWORTH: ROSE BROS. LTD.
GMF BEXLEYHEATH: SANSPEED
GMG BLETCHLEY: OXON BUCKS E.D.S.
GMH EASTBOURNE: J.W. STEVENS LTD.
GMI AATHERTON: W.C.R. AUTOCARE
GMJ WREXHAM: WREXHAM AUTO ELECTRIC



M

GMK BRENTWOOD: TRIGGS GARAGE
 GMP NANTGARW: MOTOLECTRIC
 GMR NOTTINGHAM: AUTOPLUS LTD.
 GMT STUDLEY: BOB ROTTNER TUNING
 GMU BRISTOL: LODWAY SERVICE STATION
 GMV WAKEFIELD: LAMPORT & SON
 GMW LONDONSE 7: GREENWICH TUNING
 GMZ BEDFORD: FENLAKE A.E.S.

N

GNB LUTON: R.M.FENSOME & CO.
 GNC LONDON NE10: SPIROS MOTOR TECHNICIANS
 GND FRISKNEY: CORTEN MILLER GARAGE LTD.
 GNE LICHFIELD: CENTRAL GARAGE
 GNF BEXHILL: AUTOTECHNICS (BEXHILL) LTD.
 GNG CARDIFF: INDUSTRIAL DIESEL SERVICES
 GNH DORKING: R.W.TUTT CO. LTD.
 GNI BARROW: KITCHIN & CALVERT LTD.
 GNJ LONDON SW14: FERRY MOTORS LTD.
 GNK GODALMING: PHILLIPS OF WORMLEY
 GNL NEWPORT: SUPER TUNE
 GNM RAINHAM: ELMPARK VEHICLE ELECTRICS
 GNN SCUNTHORPE: A.D.E.S. LTD.
 GNR LINLITHSOW: TARDUFF MOTORS
 GNS IPSWICH: ORWELL AUTO ELECTRICS
 GNT SPALDING: R.C.EDMONDSON
 GNU HEREFORD: BULLOCK & EVANS
 GNV POTTERS BAR: POTTERS BAR TUNING CENTRE
 GNX NORWICH: F.M.C. AUTOTECHNIC
 GNY NORSEY, C.I.: AUTO ELECTRIC (S & S) LTD.
 GNZ PLYMOUTH: PHILIP DAVIS

O

GOA HOUNSLOW: HOUNSLOW AUTO
 GOB LEWES: MORRIS ROAD GARAGE
 GOC OTTERY ST.MARY: T.S.S.AUTODIAGNOSTIC LTD.
 GOD GLASGOW: BYRES ROAD GARAGE
 GOE WESTON-SUPER-MARE: QUEENSWAY MOTOR SERVICE
 GOF KINGSTON: VETECH
 GOG DALASTON: HEATH MOTORS
 GOH BIRMINGHAM: SWAN MOTORS
 GOI FALKIRK: MCWATT & TURNBULL
 GOJ NEWTON ABBOT: MONNINGTON MOTORS
 GOK SELBY: D.Y. MOTOR ENGINEERING
 GOL KNIGHTON: BROOKSIDE AUTO ELECTRICS
 GOM ROTHERHAM: MOTORTUNE
 GON ROTHERHAM: WILKINSONS A.E.LTD
 GOO STEVENAGE: VINCENT ELECTRO-INJECTION
 GOF DERBY: BELLINIS



O

GOR CONVENTRY: REGENCY MOTORS LTD
 GOS OLDBURY: ENTERPRISE GARAGE
 GOT ASHFORD: IVYDENE LTD.
 GOU CASTLEFORD: COLLINSON & STELLING LTD
 GOV ROCHESTER: FOUR ELMS SERVICE STATION
 GOW BRIDGWATER: TIM STILES RACING
 GOX NEW MILTON: MARTIN PILLEY SERVICES
 GOY LONDON HA9: TARGA AUTOS LTD
 GOZ YSTRADMYNACH: AUTOMATED

P

GPA NOTTINGHAM: BROOK MOTOR ENGINEERS
 GPB READING: DOUBLE'S GARAGE
 GPD BROMSGROVE: S.H.AUTO ENGINEERING
 GPF MARKET DRAYTON: CLARKE SERVICES
 GPG BIRMINGHAM: PERSHORE ROAD SERVICE
 GPH ALTRINGHAM: MONEYSAVE SERVICE STATION
 GPI WISBECH: A.&B.AUTO ELECTRICAL SERVICES
 GPJ BRISTOL: HALLS AUTO ELECTRICS
 GPK WARRINGTON: KINNOR SERVICES
 GPL GLOSSOP: RELIANCE GARAGE
 GPM LEEDS: J.GREAVES
 GPN SAFFRON WALDON: SAFFRON AUTO
 GPO HEMEL HEMPSTEAD: LEVERSTOCK MOTOR SERVICES
 GPP GERRARDS CROSS: GRAYSHEEN
 GPR HORSHAM: D.A.HOWES
 GPS WITNEY: J.MILLIN & SON
 GPU BURTON ON TRENT: TONY PRESS CARS
 GPV LOUGHTON: ANDREW H.YOUNG
 GPW COVENTRY: NORTH ST GARAGE
 GPX LOUTH: R.ALEXANDER
 GPY CLACTON: (W.A.) SYRETTS GARAGE LTD
 GPZ TELFORD: ROUTE 65

R

GRA SWANSEA: CITY E.D. SERVICE
 GRB ALFRETON: H J MORRIS MOTORS LTD
 GRC LEICESTER: A.D.S.O. AUTO ELECTRIC
 GRD BOLTON: PETER MICHAELS
 GRE GLASGOW: CUMMING AUTOMOTIVE
 GRF LANARK: J & J FERGUSON
 GRG RUNCORN: ASTMOOR BRIDGE GARAGE
 GRI PRESCOT: NEW ROAD GARAGE
 GRJ CHORLEY: WELDBANK GARAGE
 GRK PURFLEET: RUSH ENGINEERING
 GRL HAILSHAM: DIPLOCK F.I.S. LTD
 GRM FLYMPTON: CARBURATION & INJECTION
 GRN AIRDRIE: TORVIL AUTO ELECTRICS
 GRO LEICESTER: SCUDAMORE MOTOR CO.



R

GRP COLERNE: INNOX GARAGE LTD
GRR HUNTINGDON: BRAMPTON AUTO ELECTRIC
GRT CHESTERFIELD: BARROW HILL SERVICE STATION
GRU MELTON MOWBRAY: COLEMAN BROTHERS
GRV BRISTOL: KINGSWAY GARAGE
GRW BARNET: BARNET SERVICE & TUNING CENTRE
GRX WATFORD: FALCON ENGINEERING
GRY BROADWAY: ALAN ASTON
GRZ CHESTERFIELD: A F TUNING

S

GSB LIVERPOOL: DIESEL & BATTERY SERVICES
GSD LUTON: UNION ST AUTOS
GSF MANCHESTER: A.E.S. (MANCHESTER) LTD
GSG PUDSEY: D C WOODHEAD
GSH BEVERLEY: LAIRGATE MOTORS
GSI GRIMSBY: P J PRESTON
GSJ SHEFFIELD: MELLOR ELLIOT MOTORSPORT
GSK MARPLE: H BRADDOCK & SON LTD
GSL KIDDERMINSTER: TRANSPORT & PLANT SERVICES
GSN DUNDEE: ROBERT LAWSON
GSO STOKE: V C SAVAGE
GSP DUDLEY: BURNT TREE SERVICES
GSR GUILDFORD: A.D.E.S. (SURREY) LTD

T

GTB SUDBURY: J & J HOWLETT
GTC HALSTEAD: LANCE ELECTRONICS
GTD PORT TALBOT: AUTOLEC SERVICE
GTE BRADFORD: AUTOLECTRO
GTF SEVENDAKS: JOHN BOWLES
GTG WASHINGTON: M & R COMPONENTS LTD
GTH WISBECH: D & J S WILSON MOTOR ENGINEERS
GTI HIGH WYCOMBE: MERITUNE SPECIALISTS LTD
GTJ ST ALBANS: R M MOTORS
GTK HARROGATE: AUTO TECHNIK
GTL PETERBOROUGH: AUTOSPARTS
GTM BERKHAMSTEAD: KINGS ROAD GARAGE LTD
GTN DUNDEE: MOTOPARTS
GTO WREXHAM: RUABON ROAD AUTOCLINIC
GTP SCUNTHORPE: SURESTART
GTR HELSTON: THE AUTO CENTRE
GTS EDINBURGH: G THOMSON (A.E.) LTD
GTT LETCHWORTH: BARDELL & BRYNE
GTU LAINDON: LAINDON AUTO TECHNIQUE
GTV RUGBY: MOSERVE
GTW WARLEY: WARLEY CONTINENTAL SERVICES
GTX DARLINGTON: AUTO ELECTRICS LTD
GTY HITCHIN: AUTO SERVICE & TUNING CENTRE

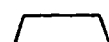

T

GTZ STOKE-ON-TRENT: BLAKE STREET GARAGE LTD

6. NIEDERLANDE, NETHERLANDS, LES PAYS-BAS, PAISES BAJOS, PAESI BASSI,



A

HAA RIJNSBURG: B.V. ELECTRA BRANDT
HAB ALKMAAR: METZELAAR TECHNIEK B.V.
HAC DEVENTER: KRUITBOSCH & DE WEERD B.V.
HAD ZWOLLE: P.B. VENEMA B.V.
HAE MAASTRICHT: TECHN. HANDELSONDERN. VAN KAPPEL B.V.
HAF TILBURG: AFS B.V.
HAG GORINCHEM: STRAGO ELECTRO B.V.
HAH ROTTERDAM: KOTHAR B.V.
HAI GOES: VAN DER PEIJL TECHNIEK B.V.
HAJ UTRECHT: L.J.J. VAN GEFFEN B.V.
HAK DEN BOSCH: VAN DER LEEDEN B.V.
HAL NAALDWIJK: AUTO-ELECTRA NAALDWIJK B.V.
HAM BUSSUM: HARRY BANIS B.V.
HAF DRACHTEN: TURKSTRA-LASAULEC B.V.
HAR LEEUWARDEN: VEAM-ROORDA B.V.
HAS VEGHEL: ZANTEN B.V.
HAT NIEUWPOORT: C.RENES B.V.
HAU DOETINCHEM: VAN SILFHOUT B.V.
HAV CUYK: OSKARO B.V.
HAW VALKENSWAARD: TECHN.BUR.KAN B.V.
HAX BERGEN OP ZOOM: TECHN.HANDELSONDERN.C.M.AKKERMANS B.V.
HAY PAPENDRECHT: ROVANDA B.V.
HAZ NIJMEGEN: TECHN.BUR. HOLL B.V.

B

HBA HOORN: TECHN. HANDELSBUREAU JOBE
HBB KLAASWAAL: TERLOUW AUTO ELECTRA B.V.
HBC ASSEN: OOSTLAND TECHNIEK B.V.
HBD HARDERWIJK: DIESEL BÜCHLI
HBE HILVERSUM: FIRMA DAAN WERNSEN
HBG SNEEK: TURKSTRA-LASAULEC B.V.
HBH RIJSSSEN: TEUNIS RIJSSSEN B.V.
HBJ GOUDA: DIESEL SERVICE ROB STOKKING B.V.
HBK VEENENDAAL: HOOGVEEEN AUTO-EL-DIESELSERVICE V.O.F.
HBL EMMELOORD: DIESELSERVICE EMMELOORD B.V.
HBM COEVORDEN: CHRIS WARMING B.V.
HBN UDEN: OSKARO B.V.
HBO TERNEUZEN: VAN DER PEIJL TECHNIEK
HBP HOENSBROEK: OTERMANS AUTOTECHNIEK
HBR LEIDEN: EL.TECHN.BUR.DE JONG & ZN.LEIDEN B.V.
HBS ROOSENDAAL: LIPS & VAN DE CORPUT B.V.
HBU HOOGVEEEN: HEMMEN B.V.
HBV ALMELO: VOGELSANG BOSCH SERVICE
HBW ALPHEN A/D RIJN: AUTO EL.ALPHEN A/D RIJN B.V.
HBX TILBURG: VAN GEEL B.V.
HBY WEERT: FIRMA GEBR. VAN KAPPEL
HBZ ENSCHEDE: BOSCH SERVICE HERMAN BOSCH

6. NIEDERLANDE, NETHERLANDS, LES PAYS-BAS, PAISES BAJOS, PAESI BASSI,

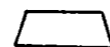

C

HCD EDE: J.SMITS DIESELSERVICE-AUTO-ELEKTRO
HCF OLDENZAAL: OLDENZAALSE AUTOMATERIALEN
HCG AMSTERDAM: ARCOMO AUTO-ELECTRONICA
HCH AMERSFOORT: TECHNO CAR - TECHNOTRUCK B.V.
HCJ EINDHOVEN: IDEE CAR TRUCK SYSTEMS B.V.
HCK KERKRADE: FIRMA BORKOWITZ
HCL WINTERSWIJK: VAN SILFHOUT WINTERSWIJK B.V.
HCM WINSCHOTEN: P.B. VENEMA B.V.
HCP OOSTERHOUT: AFS B.V.
HCR ALMERE: HARRY BANIS B.V.
HCS HEEREVEEN: TURKSTRA-LASAULEK B.V.
HCU HENGEL: LANGENDONK VMT B.V.

N

HNA BLADEL: HUVA AUTOMATERIALIEN BLADEL B.V.
HNB GRONINGEN: P.B. VENEMA B.V.
HND MAASTRICHT: FERNAND VAN DEN DIJCK
HNE ARNHEM: SCHARIJN-ARNHEM B.V.
HNF HAARLEM: METZELAAR TECHNIEK B.V.
HNG HILVERSUM: EGELS HILVERSUM
HNJ ENSCHEDE: TE RIET-ENSCHEDA ELEKTROTECHNIEK B.V.
HNM BREDA: AFS B.V.
HNS EMMEN: AUTOTECHNIEK HARM RENGERS B.V.
HNV VENLO: TECHN.HANDELSONDERN. VAN KAPPEL B.V.
HNW BREDA: T.B. BAM B.V.
HNX MELICK: NEDAM-ROERMOND B.V.

S

HST DEN HELDER: ELECTROSTART B.V.

W

HWR AMSTERDAM: WILLEM VAN RIJN B.V.

6. ITALIEN, ITALY, ITALIE, ITALIA, ITALIA,



A

IAA 20149 MILANO (MI): ROBERT BOSCH S.P.A.
 IAB 60131 ANCONA (AN): S.I.M.E. S.P.A.
 IAC 50013 CAMPI BISENZIO (FI): C.E.D. SNC
 IAD 70124 BARI (BA): DEMAUTO S.P.A.
 IAE 24100 BERGAMO (BG): R.A.B. S.R.L.
 IAG 25100 BRESCIA (BS): D.B.E. S.P.A.
 IAH 39100 BOLZANO/BOZEN (BZ): STAFFLER S.R.L.
 IAI 09047 SELARGIUS (CA): S.D.R. S.P.A.
 IAJ 22100 COMO (CO): D.E.C.A. SRL
 IAK 12020 MADONNA OLMO (CN): G.S. S.P.A.
 IAM 95122 CATANIA (CT): C.I.R.E. SPA
 IAN 50018 SCANDICCI (FI): CORAT S.P.A.
 IAO 16127 GENOVA (GE): C.D.L. S.P.A.
 IAP 55100 LUCCA (LU): CARIGNANI GIANCARLO
 IAR 58100 GROSSETO (GR): C.D.E. SNC DI SCARDIGLI
 IAS 20090 CUSAGO (MI): C.I.D.E. S.P.A.
 IAT 41100 MODENA (MO): REMSA S.P.A.
 IAU 80020 CASAVATORE (NA): SIDRA S.R.L.
 IAV 90143 PALERMO (PA): D.R. S.P.A.
 IAW 35129 PADOVA (PD): S.I.R.E. SRL
 IAX 53100 SIENA (SI): REDAM MINUCCI & BATTI
 IAY 06100 PERUGIA (PG): ZUCCHETTI SNC

B

IBA 27028 S. MARTINO SIC. (PV): D.R.A. S.P.A.
 IBB 00155 ROMA (ROMA): C.I.M.E. SPA
 IBC 17100 SAVONA (SV): VIVALDI ELETTROFORNITURE
 IBD 10070 MAPPANO (TO): S.B.L. S.P.A.
 IBE 53036 POGGIBONSI (SI): CAMPATELLI RENZO
 IBF 33100 UDINE (UD): TECNORICAMBI S.R.L.
 IBG 10146 TORINO (TO): VOLPE CESARE
 IBH 01100 VITERBO (VT): MINELLI EUGENIO
 IBI 52100 AREZZO (AR): SCOSCINI & DEL GAMBA SNC
 IBJ 52028 TERRANOVA BRACC. (AR): TECNODIESEL SNC DI PIERGIOVA
 IBK 52037 SAN SEPOLCRO (AR): COMEL SNC
 IBL 10078 VENARIA REALE (TO): AIDE DI ADDUCI & C. SAS
 IBM 53034 COLLE VAL D'ELSA (SI): BEVACQUA S. & C. SNC
 IBN 10154 TORINO (TO): VACCARI SNC DI LATTANZIO R.
 IBO 11015 LA SALLE (AO): OFF. F. LLI SARASINO SNC
 IBP 51100 PISTOIA (PT): BELLEGONI GINO
 IBR 51100 PISTOIA (PT): D.R.P. DI BONUCCI BARCACCI
 IBS 53040 BETTOLLE (SI): OFF. DIESEL DI FIERINI & C.
 IBT 53043 CHIUSI CITTA (SI): ALFATTI SILVANO
 IBU 53044 CHIUSI SCALO (SI): AUTORIC. FUCELLI
 IBV 51039 QUARRATA (PT): BARDELLI & GORI
 IBW 50018 SCANDICCI (FI): ELETTRAUTO CICALI
 IBY 52025 MONTEVARCHI (AR): Elett. TONELLI G. & C. SNC
 IBZ 50053 EMPOLI (FI): HAPPY AUTO

F 05

6. ITALIEN, ITALY, ITALIE, ITALIA, ITALIA,

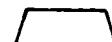

C

ICA 10147 TORINO (TO): BONANI MARIO
 ICB 10015 IVREA (TO): TRIVIO RENZO
 ICC 10128 TORINO (TO): ELETTRAUTO CANOVA & S. SDF
 ICD 10149 TORINO (TO): PERLETTO CARLO
 ICE 10139 TORINO (TO): ELETTR. FARINASSO G. & C. SN
 ICF 10138 TORINO (TO): ELETTR. GENTILINI
 ICG 10090 FERRIERE BUTTIGL. ALTO: F. LLI CAVALIERI
 ICH 10121 TORINO (TO): GI. MA. SNC DI GIANCASPRO &
 ICI 10142 TORINO (TO): ELETTR. FUCILITTI SNC
 ICJ 15015 SAN BERNARDO - IVREA: TECNO DIESEL SNC
 ICK 20127 MILANO: VERDI GARAGE
 ICL 10137 TORINO (TO): PERNACI GIULIO
 ICN 10156 TORINO (TO): SAINO BRUNO
 ICO 10148 TORINO (TO): CIMADOMO GIUSEPPE
 ICP 10154 TORINO (TO): LEGGIERO VINCENZO
 ICR 10024 MONCALIERI (TO): L'ELETTRODIESEL SNC
 ICS 10010 CANDIA CANAVESE (TO): DE SANTI LIVIO ELETTR.
 ICT 10041 CARIGNANO (TO): GRIVETTO LOCANETTO GIUSEPPE
 ICU 10034 CHIVASSO (TO): MOGAVERO ANTONIO
 ICV 10073 CIRIE (TO): BAIMA & MARANGONI
 ICW 10024 MONCALIERI (TO): DEMARCHI GIUSEPPE & C. SNC
 ICX 10051 AVIGLIANA (TO): ROMIO NAZZARENO
 ICZ 10040 LEINI (TO): SCARABOSIO F. LLI

D

IDA 10024 MONCALIERI (TO): GRIGATTI EOLO
 IDB 10024 MONCALIERI (TO): ELETTR. S.F. - DI SCOVERO &
 IDC 10094 GIAVENO (TO): NEGRO G. PAOLO
 IDD 10064 PINEROLO (TO): PATANIA SNC DI PATANIA M.
 IDH 51034 CASALGUIDI (PT): DEGL'INNOCENTI ROBERTO
 IDI 10129 TORINO (TO): ESSEBI-CAR SAS DI STORTA BAU
 IDJ 51018 PIEVE A NIEVOLE (PT): CENTRO ASS. ELETTRODIESEL
 IDK 20093 COLOGNO MONZESE (MI): BARBIERI & CORTESI
 IDM 53021 ABBADIA SAN SALVATORE: TIBERI & MAZZI
 IDN 10129 TORINO (TO): DROVETTO SNC DI DROVETTO M.
 IDO 10095 GRUGLIASCO (TO): BERRONE GIOVANNI
 IDR 53100 SIENA (SI): O.R.C.E.D. DI BROGI G. & C.
 IDS 10152 TORINO (TO): FORABOSCO GUIDO
 IDT 53036 POGGIBONSI (SI): DE SANTI & LEPRI
 IDU 13100 VERCELLI (VC): TAVANO ANGELO
 IDV 13051 BIELLA (VC): MAF SNC DI MAFFIOTTI PIERCAR
 IDW 13100 VERCELLI (VC) C.S.E. DI PROTTO P.G.
 IDX 13014 COSSATO (VC): BORIN SNC
 IDY 20053 AUGINO (MI): Elett. TAGLIABUE CLAUDIO
 IDZ 10022 CARMAGNOLA (TO): C.D.S. SNC CAVALLITO DI C.E.

F 06

6. ITALIEN, ITALY, ITALIE, ITALIA, ITALIA,

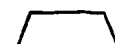

E

IEA 13039 TRINO (VC): POLLONE SERGIO
 IEB 10134 TORINO (TO): CASSINELLI & GIANOTTI
 IEC 10098 RIVOLI (TO): BONO SRL
 IED 10126 TORINO (TO): NEIROTTI GIUSEPPE SRL
 IEE 10127 TORINO (TO): ROMANO VINCENZO
 IEF 13057 POLLONE (VC): PERETTO CLAUDIO
 IEG 10148 TORINO (TO): OFFICINA F. LLI DI MAURO SNC
 IEH 10155 TORINO (TO): PIARDI SNC DI PIARDI MARIO
 IEI 10034 CHIVASSO (TO): BROGGIO & ALUFFI SNC
 IEJ 20127 MILANO: COMI MASSIMO
 IEK 10095 GRUGLIASCO (TO): PRATISSOLI USMANO
 IEL 10073 CIRIÉ (TO): FERROGLIO FRANCO
 IEM 10051 AVIGLIANA (TO): GIRARDI GIANNI
 IEN 10064 PINEROLO (TO): NICOLA & DELL'ORTO SNC
 IEO 13100 VERCELLI (VC): CAGNONI ROBERTO
 IEP 13014 COSSATO (VC): C.E.D.A. DI MAGNANI & C. SNC
 IER 13048 SANTHIA (VC): RODIGHIERO GIANNI
 IES 28013 GATTICO (NO): ELETTRDIESEL DI RENZO BONEL
 IET 13051 BIELLA (VC): SASSO PIETRO DI SASSO G. & C
 IEU 11020 ST. CHRISTOPHE (AO): AUTORIPARAZIONI SCANDONE & B
 IEV 10067 VIGONE (TO): CORDANI ROBERTO
 IEW 10128 TORINO (TO): G.T. DI TOGNON & C. SNC
 IEX 10123 TORINO (TO): AUTOPLANA SNC DI F.LLI RISTA
 IEZ 10010 BUROLO (TO): SERVIZIO DIESEL

G

IGA 12042 BRA (CN): F.LLI MILANO GIUSEPPE & BIAG
 IGB 12051 ALBA (CN): MARENCO RENATO
 IGC 12100 CUNEO (CN): GIACCONE UGO ELETTRDIESEL
 IGE 12011 BORG SAN DALMAZZO (CN): MARTINI ELIO
 IGF 12022 BUSCA (CN): PRATO CARLO
 IGG 12073 CEVA (CN): BARAVALLE MICHELE
 IGH 12063 DOGLIANI (CN): ALBARELLO BRUNO
 IGI 12045 FOSSANO (CN): WACHTEL HARALD
 IGJ 12084 MONDOVI (CN): MIGLIORE & VINAI
 IGK 12068 NARZOLE (CN): ELETTRAUTO DINO DI B. GANDIN
 IGM 12037 SALUZZO (CN): PIGNATTA EGIDIO GIOVANNI
 IGN 12038 SAVIGLIANO (CN): BORIO FILIPPO & C. SNC
 IGO 12040 SANT'ALBANO ST (CN): ROCCA CARLO ELETTRAUTO
 IGP 12020 SAN ROCCA BERNEZZO (CN): FANTINO DALMAZZO STEFANO
 IGS 14100 ASTI (AT): SEA DI NEGRO EMILIO & C. SNC
 IGT 14048 MONTEGROSSO (AT): SEA DI MONDO PRUNOTTO
 IGU 14054 CASTAGNOLE LANZE (AT): CERRATO MARIO
 IGV 14100 ASTI (AT): AMERIO GIUSEPPE
 IGW 14053 CANELLI (AT): SA. BO. DI SANTARSIERO & BOS
 IGX 14100 ASTI (AT): TECNO DIESEL SNC
 IGY 14100 ASTI (AT): SPECIAL DIESEL MARCHISONE
 IGZ 12051 ALBA (CN): PAGLIANO G. & BODDA G. SNC

F 07

6. ITALIEN, ITALY, ITALIE, ITALIA, ITALIA,



H

IHB 12011 BORG SAN DALMAZZO (CN): TECNODIESEL DI SCANDONE A.
 IHC 52037 SANSEPOLCRO (AR): TECNODIESEL DI BONINSEGNA
 IHD 12084 MONDOVI (CN): FORZANO MARIO
 IHE 12037 SALUZZO (CN): ARDUSSO GIUSEPPE
 IHF 12038 SAVIGLIANO (CN): MIGLIORE GIANMICHELE
 IHS 12042 BRA (CN): TAVERNA GIOVANNI & FIGLIO

I

IIB 15055 FONTECURONE (AL): LONGHI & BARIANI SNC
 IID 15048 VALENZA (AL): LENTI EPIS & C. SNC
 IIE 15100 ALESSANDRIA (AL): SCAGLIONE & SASSOLA SNC.
 IIF 15057 TORTONA (AL): F.I.A.S. DI CORTELLA A.
 IIG 15050 SAN GIULIANO VECCHIO: BASSO & TORTI SDF
 IIH 15011 ACQUI TERME (AL): DE MICHELIS Elett. SNC
 III 15033 CASALE MONFERRATO (AL): ARSENIATO LUIGI
 IIJ 15100 ALESSANDRIA (AL): VILLAVECCHIA SNC
 IIK 27029 VIGEVANO (PV): EL DEI F.LLI GENOVESE SDF
 IIL 15033 CASALE MONFERRATO (AL): CAVAGNOLO & BELLOMO SNC
 IIM 15033 CASALE MONFERRATO (AL): ELETTRD. F.LLI GUERCI G. &
 IIN 20030 LENTATE S. SEVESO: CIDIERRE CAR STEREO SNC
 IIP 15023 FELIZZANO (AL): GOTTA RENZO
 IIR 15067 NOVI LIGURE (AL): ELETTRAUTO DI BAILO ETTORE
 IIS 27100 PAVIA (PV): CHICCHINI SAS
 IIT 27100 PAVIA (PV): ZALIANI LUIGI & C. SNC
 IIU 27100 PAVIA (PV): ZACCHETTI & ZAVOLI
 IIV 27100 PAVIA (PV): ZAMPETTI FRANCESCO
 IIX 27050 TORRAZZA COSTE (PV): GHIA ROMANO ELETTRDIESEL
 IIY 27012 CERTOSA PAVIA (PV): MASSOLINI FRANCESCO

J

IJA 27026 GARLASCO (PV): GIAN FRANCO & MARIO PILERIO
 IJB 27036 MORTARA (PV): RAVA EDELIO
 IJC 27038 ROBBIO (PV): F.LLI DELLA CA'GIACOMO & MA
 IJD 27029 VIGEVANO (PV): NAI FLAMINIO & SALA ROBERTO
 IJE 27058 VOGHERA (PV): DALLOCCHIO & FRANCHINI
 IJF 27058 VOGHERA (PV): AUTOMEG DI RUSSO
 IJG 27058 VOGHERA (PV): BETTAGLIO FINO SNC
 IJH 27100 PAVIA (PV): ELETTRAUTO CASTELLO DI MEREG
 IJJ 27029 VIGEVANO (PV): ZANOVELLO GRECO & SALA SNC
 IJK 27019 VILLANTERIO (PV): DAGRADA CARLO & FIGLI SNC
 IJL 15100 ALESSANDRIA (AL): CAPRIATA GIOVANNI & C. SNC
 IJM 15011 ACQUI TERME (AL): PERUZZO ADRIANO
 IJN 15067 NOVI LIGURE (AL): PICCININI & SALA DI PICCININI
 IJO 15057 TORTONA (AL): GRASSI & ROMAGNOLI
 IJP 15057 TORTONA (AL): BONETTI CARLO
 IJR 15057 TORTONA (AL): PICCININI & SALA SAS
 IJS 27028 SAN MARTINO SICCOMARIO: PICCININI SALA & C. SNC
 IJT 27035 MEDE (PV): DAN VIRGINIO
 IJU 27058 VOGHERA (PV): ERCOLANI GUIDO

F 08

6. ITALIEN, ITALY, ITALIE, ITALIA, ITALIA,



J

IJV 27100 PAVIA (PV): SERVIZIO ROTAZIONE MOTORI
 IJW 20075 LODI (MI): CASSINELLI GIANFRANCO

L

ILA 20133 MILANO (MI): VI EFFE SAS
 ILB 20149 MILANO (MI): TURATI G. & CIPPONE C. SNC
 ILC 20149 MILANO (MI): WEBAUTO S.P.A.
 ILD 20075 LODI (MI): AUTOFFICINA ROSSI CESARE
 ILE 20090 CESANO BOSCONI (MI): C.R.P.D. SNC DI REVERSI MARI
 ILF 20033 DESIO (MI): E.A.R.F.I. SNC DI BOCA
 ILG 20010 BAREGGIO (MI): COSTA GIAN MARIO
 ILH 20011 CORBETTA (MI): AUTORIP. PATRINI A.
 ILI 20052 MONZA (MI): OFF. ELETT. SERRA
 ILJ 20059 VIMERCATE (MI): O.R.E.M./MERONI CARLO
 ILK 20090 CESANO BOSCONI (MI): MINGORI LUIGI ELETTR.
 ILL 20010 CANEGRATE (MI): LABORATORIO ELETTR. D. BOLLA
 ILM 20075 LODI (MI): ELETTRAUTO NERVI LUIGI
 ILN 20146 MILANO (MI): ARLOTTI MOTORSPORT
 ILO 20133 MILANO (MI): PEZZENATI GIAMPIERO
 ILP 20135 MILANO (MI): PAGHINI MORENO & C. SNC
 ILR 20030 CASTELLETTO DI SENAGO: BOTTARO F.LLI
 ILS 20035 LISSONE (MI): AUTOTECNICA SNC DI G. & Z.
 ILU 28037 DOMODOSSOLA (NO): JANNI GIUSEPPE
 ILV 28066 GALLIATE (NO): BENASSI FRANCO
 ILW 28026 OMEGNA (NO): TOSI & BARUZZO SNC DI T. & B.
 ILX 28100 NOVARA (NO): ELETTRODIESEL
 ILY 28100 NOVARA (NO): ELETTR. CORCIARINO SNC
 ILZ 20143 MILANO (MI): BELLATI & BERTA SNC

M

IMA 20153 MILANO (MI): TECNODIESEL
 IMB 20091 BRESSO (MI): CENTIMERI A. & C. SNC
 IMD 20100 MILANO (MI): FAGNANI PASQUALE
 IME 20010 BOFFALORA TICINO (MI): FORTA LUIGI
 IMF 20073 CODOGNO (MI): COTTI RENATO
 IMG 20052 MONZA (MI): O.E.M.A. DI COLNAGO A.
 IMH 20063 CERNUSCO S. NAVIGLIO: TADINI GIUSEPPE
 IMI 20139 MILANO (MI): ELETTR. BRONI DI BOVE M.
 IMJ 20014 NERVIANO (MI): CARLONI BRUNO
 IMK 20017 RHO (MI): GHIEMMETTI F.LLI OFF. SNC
 IML 20144 MILANO (MI): ORPID F.LLI BURATTI
 IMM 20146 MILANO (MI): G.B. DIESEL DI L. & B. SNC
 IMN 20026 NOVATE MILANESE (MI): OFF. MECC. M.T.
 IMO 20018 SEDRIANO (MI): NUOVA DIESEL DI P. CORNAGGIA
 IMP 20035 LISSONE (MI): O.E.R.F.I.
 IMR 28100 NOVARA (NO): O.D.A. DI AGNESINA
 IMS 28100 NOVARA (NO): RODINI & BERETTA ELETTR.
 IMT 28037 DOMODOSSOLA (NO): CASSETTI F.LLI SDF
 IMU 20128 MILANO (MI): AUTOFFICINA DE MARCHI

6. ITALIEN, ITALY, ITALIE, ITALIA, ITALIA,

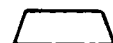

M

IMV 20162 MILANO (MI): BASSALTI A. & G.
 IMW 20158 MILANO (MI): CROTTI VITTORIO
 IMX 20152 MILANO (MI): ELETTRAUTO BAGGIO S.D.F.
 IMY 20090 VIMODRONE (MI): RURALE GIANCARLO AUTOFFICINA
 IMZ 20141 MILANO (MI): AUTOFFICINA DE SANCTIS

N

INA 20158 MILANO (MI): ASCOLI VITTORIO & C. SDF
 INB 20037 PADERNO DUGNANO (MI): SEREGNI SILVANO ELETTRAUTO
 INC 20144 MILANO (MI): FIORENTINI BRUNO
 IND 20125 MILANO (MI): VALSECCHI G. ELETTR. SNC
 INE 20011 CORBETTA (MI): BOLDRINI G. ELETTRAUTO
 INF 20158 MILANO (MI): VARE' SUPERCAR SRL
 ING 20122 MILANO (MI): ELETTR. ROVERI DI BIASIOTTO
 INH 20044 BERNAREGGIO (MI): VARISCO WALTER
 INI 20071 CASALPUSTERLENGO (MI): FOLLI FRANCO
 INJ 20048 CARATE BRIANZA (MI): POZZOLI A. ELETTRAUTO
 INL 20025 LEGNANO (MI): ELETTR. BERTANI ROBERTO
 INM 20077 MELEGNANO (MI): SCURI OSVALDO
 INN 20066 MELZO (MI): AUTOFFICINA MARELLI SNC
 INO 20013 MAGENTA (MI): ELETTRAUTO CAVALLAZZI BRUNO
 INF 20086 MOTTA VISCONTI (MI): ELETTR. S. ANNA DI ANDREONI
 INR 20037 PADERNO DUGNANO (MI): SEREGNI ROBERTO
 INS 20015 SAN LORENZO DI PARAB.: ELETTRAUTO SEMPIONE
 INT 20016 PERO (MI): BARBETTI & MARAZZI SNC
 INU 20029 TURBIGO (MI): AUTODIESEL DI PAGANOTTO G.
 INV 20039 VAREDO (MI): CANDIVI BATTISTA ELETTRAUTO
 INW 20124 MILANO (MI): GENGHINI ROBERTO
 INX 20049 CONCOREZZO (MI): AUTORACING SNC
 INY 20092 CINISELLO BALSAMO (MI): AUTOLEADER SNC
 INZ 20090 CUSAGO (MI): TURATI G. & CIPPONI C. SNC

O

IOA 24100 BERGAMO (BG): AIROLDI LINO
 IOB 24100 BERGAMO (BG): CARRARA G. BATTISTA
 IOC 24050 GRASSOBIO (BG): ELETTR. CRIPPA
 IOE 24021 ALBINO (BG): VEDOVATI ANGELO & C. SNC
 IOF 24011 ALME (BG): ELETTR. GHEZZI PIERO
 IOG 24019 ZOGNO (BG): CORTINOVIS LUIGI
 IOH 24024 GANDINO (BG): LIISTRO VINCENZO
 IOI 24020 SCANZOROSCIATE (BG): GIUDICI LUCIANO
 IOJ 24058 ROMANO DI LOMBARDIA (BG): CRIPPA F. & R. SNC
 IOK 24068 SERIATE (BG): AMBROSINI EMILIO & FIGLI
 IOL 24040 ZINGONIA (BG): O.E.R.F.I. GILARDI DANTE
 ION 24060 CASTELLI CALEPIO (BG): F.LLI FAGANI R. & A.
 IOO 24060 GORLAGO (BG): VALOTA PIERANGELO
 IOP 24043 CARAVAGGIO (BG): NICOLI ERMANNIO
 IOR 24040 MADONE (BG): MAZZOLA GIORGIO
 IOS 24033 CALUSCO D'ADDA (BG): FENILI A. & C. SNC

6. ITALIEN, ITALY, ITALIE, ITALIA, ITALIA,



O

IOT 24040 CALVENZANO (BG): INVERNIZZI G. BATTISTA
 IOU 24044 DALMINE (BG): BELTRAMELLI PIERANTONIO
 IOW 24020 GORLE (BG): GARAGE 2000 DI RECCHIA & GHI
 IOX 24065 LOVERE (BG): LORINI DANILO
 IOY 24027 NEMBRO (BG): AUTOMOTOR DI ROSSETTI
 IOZ 24040 FONTIDA (BG): FOLCIO CLAUDIO

P

IPA 24100 BERGAMO (BG): ELETTRODIESEL DI ROTA SPERTI
 IPB 24061 ALBANO SANT'ALESSANDRO: MILESI F.LLI & C. SNC
 IPC 24040 PONTIROLO NUOVO (BG): QUADRI VEICOLI INDUSTRIALI S
 IPD 10148 TORINO (TO): ELETT. STORNELLO CLAUDIO
 IPE 10023 CHIERI (TO): MARMO & ZAFFARANO ELETTRAUTO
 IPF 24027 NEMBRO (BG): PEDERZANI ROMEO
 IPG 24047 TREVIGLIO (BG): CARMINATI FRANCESCO
 IPH 24030 CARVICO (BG): CARENINI GIUSEPPE
 IPI 24044 DALMINE (BG): BETTONI & TRIBBIA
 IPJ 24100 BERGAMO (BG): OFF. ASS. DIESEL DI VANNOTTI
 IPK 24068 SERIATE (BG): LONGHI DONATO
 IPL 24030 VERCURAGO (BG): ARRIGONI SERGIO F.
 IPM 24031 ALMENNO S. SALVATORE: GALIZZI ALBERTO
 IPN 24032 CALOLZIOCORTE (BG): BONAITI ATTILIO
 IPO 24100 BERGAMO (BG): PALENI AMADIO
 IPR 00152 ROMA (ROMA): ELETTRONICAUTO
 IPS 20092 CINISELLO BALSAMO (MI): MORI LUIGINO ELETTRAUTO
 IPT 20051 LIMBIATE (MI): AUTOFFICINA TE.PI.

R

IRA 25038 ROVATO (BS): SARA DI FAGANI M. & C. SRL
 IRB 25100 BRESCIA (BS): COLPANI INNOCENZO
 IRC 25027 QUINZANO D'OGGIO (BS): FAPPANI MARIO
 IRE 25067 LUMEZZANE S.A. (BS): MAFFEZZOLI ALESSANDRO
 IRF 25030 RONCADELLE (BS): GHIRARDINI BRUNO & C. SNC
 IRH 25076 ODOLO (BS): PIALORSI FELICE
 IRI 25100 BRESCIA (BS): GINO DAL GAL DEI F.LLI DAL G
 IRJ 25024 LENO (BS): BISINELLA F.LLI G. & C. SNC
 IRK 25024 LENO (BS): LENO DIESEL DI PERINI A.
 IRL 25100 BRESCIA (BS): PAGANINI & C. SNC
 IRM 25020 BORGO FONCARALE (BS): EURODIESEL SNC DI TRECCANI A
 IRO 25089 VILLANUOVA S. CLISI: NUOVA OMD DI BRIONI E.
 IRP 25055 PISOGLNE (BS): GUIZZETTI GIULIO
 IRR 25085 GAVARDO (BS): TANFOGLIO ROBERTO
 IRS 25043 BRENO (BS): PUTELLI RENATO
 IRU 25125 BRESCIA (BS): S.C.O.T. SOC. COOP.
 IRV 25017 LONATO (BS): BETTONI FRANCO
 IRW 25030 ORZIVECCHI (BS): DOTTI F.LLI
 IRX 25030 PARATICO (BS): GALLINEA FAUSTINO
 IRY 25100 BRESCIA (BS): MANTOVANI C. DEI F.LLI MANTO
 IRZ 25020 VEROLAVECCHIA (BS): NOVAMOTOR DI MININI SNC

6. ITALIEN, ITALY, ITALIE, ITALIA, ITALIA,

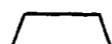

S

ISA 25080 SAN EUFEMIA (BS): AUTORIP. ARIETE DI A.
 ISB 25047 DARFO (BS): LAB. POMPE DIESEL OFFREDI C.
 ISC 25018 MONTECHIARI (BS): CIMA GIOVANNI
 ISD 25055 PISOGLNE (BS): R.P.D. DI FERRARI EROS
 ISE 25037 PONGOGLIO (BS): AUTORIP. F.LLI BELUZZI
 ISF 25018 MONTECHIARI (BS): SALVETTI FLAVIO
 ISG 25080 SAN EUFEMIA (BS): ALBERTI OSVALDO
 ISJ 25036 PALAZZOLO (BS): GARAGE MARINI MARINO
 ISK 25010 CASTELVENZAGO-LONATO: OTTOMOTOR DI OTTOLINI IVANO

T

ITA 26100 CREMONA (CR): BARBIERI & MANTELLI
 ITB 26100 CREMONA (CR): BIAGGI & NOLLI
 ITD 26100 CREMONA (CR): SCOTTI REMO
 ITG 26015 SORESINA (CR): FOZZI ALDO
 ITH 26017 TRESORE CREMASCO (CR): OGLIARI GIOVANNI MARIO
 ITJ 26038 SAN LORENZO PICENARDI: NEGRI ERMINIO
 ITL 26100 CREMONA (CR): BOSINI SRL
 ITM 26100 CREMONA (CR): CASADEI EZIO
 ITN 26025 PANDINO (CR): SAMPELLEGRINI LORENZO
 ITO 26043 PERSICO DOSIMO (CR): CREMONA POMPEINJECTOR SNC
 ITP 21054 FAGNANO OLONA (VA): CALDERA GEROLAMO
 ITR 21013 GALLARATE (VA): CARNELLI ANDREA & FIGLIO SNC
 ITS 90146 PALERMO BIONDINO CARLO
 ITV 21050 GORLA MAGGIORE (VA): PIZZAGALLI LUIGI

U

IUA 22100 COMO (CO): AUTOELETTRICITA' DI CASPANI
 IUB 22077 OLGIATE COMASCO (CO): ELETTRODIESEL DI GRACI S.
 IUC 22040 ALZATE BRIANZA (CO): TREZZI F.LLI
 IUD 22077 OLGIATE COMASCO (CO): GENTILINI DI GENTILINI A.
 IUG 22064 CASATENOVVO (CO): CAR'S ELECTRIC CENTER
 IUH 22012 CERNOBBIO (CO): AUTOR. VALBREGGIA DI RIVA
 IUI 22036 ERBA (CO): LURATI ANGELO
 IUJ 22053 LECCO (CO): CARBURATORI BALLABIO C. & G.
 IUK 22040 MALGRATE (CO): SPREAFICO ALESSANDRO
 IUL 22017 MENAGGIO (CO): OLGIATI VITTORIO
 IUN 22060 NOVEDRATE (CO): GATTI BRUNO
 IUO 26100 CREMONA (CR): CLIMATIZZAZIONE ELETT. CARB.
 IUP 22071 CADORAGO (CO): BIANCHI & VAGO SNC
 IUR 22049 VALMADRERA (CO): AIROLDI ERCOLE
 IUS 22050 GARLATE (CO): GIORGIO ELETTR. DI COLOMBO
 IUU 23032 BORMIO (SO): PINARDI FEDRO
 IUV 23022 CHIAVENNA (SO): VANINETTI DANTE
 IUW 23014 ANDALO VALTELLINO (SO): MALACRIDA LORENZO
 IUX 23037 TIRANO (SO): NAZZARI FRANCO LUIGI
 IUY 21100 VARESE (VA): ELETT. MILLE MIGLIA DI CRUGN
 IUZ 21028 TRAVEDONA (VA): ATOM SNC DI GIULIANI C. & M.

6. ITALIEN, ITALY, ITALIE, ITALIA, ITALIA,

V

IVA 21057 OLGiate OLONA (VA): AZIMONTI & COZZI SNC
 IVB 21052 BUSTO ARSIZIO (VA): BRAZZELLI ADELIO
 IVC 21054 Fagnano OLONA (VA): CALDERA GEROLAMO
 IVE 21046 MALNATE (VA): CACCIVIO CARLO
 IVF 21047 SARONNO (VA): E.P.I.F. DI PAGANI ANGELO &
 IVG 21100 VARESE (VA): BIANCHI VENANZIO DI BIANCHI
 IVH 21052 BUSTO ARSIZIO (VA): GUSSONI ALDO
 IVI 21051 ARCISATE (VA): MATASSA LUIGI
 IVJ 21026 GAVIRATE (VA): MARELLI & POZZI SRL
 IVK 21015 LONATE POZZOLO (VA): BENETTI ALFREDO & C. SNC
 IVL 21044 CAVARIA (VA): BETTINI ELETTRAUTO
 IVM 21019 SOMMA LOMBARDO (VA): BACCAGLINI GUIDO & C. SNC
 IVN 21040 VENEGONO INFERIORE (VA): BIANCHI GIANNI & C.
 IVO 21022 AZZATE (VA): OLDANI FRANCO SNC
 IVP 21052 BUSTO ARSIZIO (VA): BRAZZELLI LUIGI DI BRAZZELLI
 IVR 22100 COMO (CO): OMRA-DI LISINO & C. SNC
 IVS 22070 GRANDATE (CO): BIANCHI & CORVI DI CORVI A.
 IVT 22053 LECCO (CO): BECCALLI ARTURO & C. SNC
 IVV 22055 MERATE (CO): ROTA MARIO
 IVW 22070 OLTRONA SAN MAMETE (CO): A.U.D.I. DI PAGANI & C. SNC
 IVX 23100 SONDRIO (SO): FAGANONI PIETRO
 IVY 23014 DELEBIO (SO): INVERNIZZI GIUSEPPE
 IVZ 21100 VARESE (VA): MOIA & ROSSI DI MOIA F.&C.

W

IWA 21052 BUSTO ARSIZIO (VA): FERRARIO VITTORIO
 IWB 21040 VENEGONO INFERIORE (VA): MOSCONI MARIO
 IWC 21040 CISLAGO (CO): MANTEGAZZA FERNANDO
 IWE 22036 ERBA (CO): FUSI CLAUDIO
 IWF 22066 MARIANO COMENSE (CO): GALIMBERTI & VARENNA
 IWG 22067 MISSAGLIA (CO): VILLA MARIO & C.
 IWI 23100 SONDRIO (SO): ELETTR. BUGLIO SNC
 IWJ 21100 VARESE (VA): MINAZZI ARNALDO & C. SNC
 IWK 21022 AZZATE (VA): R.I.D. DI GORINI LENELIO
 IWM 21013 GALLARATE (VA): AUTOFF. C. PAROLO
 IWN 21056 INDUNO OLONA (VA): OFF. ELETTR. VALCERESIO
 IWO 21018 SESTO CALENDE (VA): ELETTRODIESEL DI BOFFO OSCAR
 IWP 22054 MANDELLO LARIO (CO): INGROSSO ANTONELLO
 IWR 22040 BARZIO (CO): GORETTI GIORGIO
 IWS 21053 CASTELLANZA (VA): GARAGE LOMBARDA DI LISCAIO
 IWZ 24021 ALBINO (BG): VEDOVATI MASSIMO

X

IXB 37100 VERONA (VR): CORDIOLI F.LLI
 IXC 46044 GOITO (MN): BERTI B. & MONDINI A. SNC
 IXD 37051 BOVOLONE (VR): GONZO ROBERTO
 IXE 37100 VERONA (VR): VULGOM SNC DI BONI
 IXF 37045 PORTO LEGNAGO (VR): ELETTR. MARCHIORI & SEGANTIN
 IXG 37060 RONCOLEVA (VR): SOAVE ALBERTO

6. ITALIEN, ITALY, ITALIE, ITALIA, ITALIA,

X

IXI 37131 VERONA: BUSACCHI GIUSEPPE ELETTR.
 IXJ 37066 SOMMACAMPAGNA (VR): FRACCAROLI & CORDIOLI
 IXK 37069 VILLAFRANCA (VR): MARCHINI & MELOTTO
 IXM 37026 PESCANTINA (VR): F.LLI CHESINI C. & V.
 IXN 37053 CERE A (VR): FERRARI MARIO
 IXO 37030 COLOGNOLA COLLI (VR): GUGLIELMI ADELINO
 IXR 37047 SAN BONIFACIO (VR): OFFICINA ELETTRAUTO MARCONI
 IXT 37054 NOGARA (VR): MORATTI ELETTR. SNC
 IXU 37025 PARONA (VR): FIGHI & FEDRIGHI
 IXW 37100 VERONA (VR): MANGANOTTI SNC OFF. ELETTR.
 IXX 37050 ISOLA RIZZA (VR): LORENZONI L. & L.
 IXY 46100 MANTOVA (MN): MOI ALBERTO
 IXZ 46038 S. GIORGIO (MN): CAMPI SNC DI L. & F. CAMPI

Y

IYA 46043 CASTIGLIONE D. STIV.: MISSERINI F. LLI SNC DI ADRIA
 IYB 46040 CERLONGO (MN): BOLDI RINO
 IYC 46014 CASTELLUCCHIO (MN): DALBONI LINO OFF. ELETT.
 IYD 46019 VIADANA (MN): ZAFFANELLA LUCIANO
 IYF 46040 GUIDIZZOLO (MN): GIBERTONI ROMOLO
 IYG 37012 BUSSOLENGO (VR): F.LLI FIUMINI
 IYH 38017 MEZZOLOMBARDO (TN): RONCADOR PAOLO
 IYI 38088 SPIAZZO RENDENA (TN): COZZIO EMILIO & C. SNC
 IYJ 38010 SARONICO (TN): ZUCOL LUCIANO
 IYK 38014 CANOVA DI GARDOLO (TN): COSTA GIOVANNI
 IYL 38062 ARCO (TN): F.LLI MATTEI SNC
 IYM 38010 RALLO/TASSULLO (TN): AUTOR. RIC. DI VALENTINI S.
 IYN 38066 RIVA GARDA (TN): CASTELLANI LUIGI NINO
 IYO 38068 ROVERETO (TN): MONTE F.LLI SNC
 IYP 38014 GARDOLO (TN): POPPI GIANFRANCO
 IYR 38100 TRENTO (TN): RIGO UBALDO ELETTRAUTO
 IYS 38100 TRENTO (TN): FUCHER ALESSANDRO ELETTR.
 IYT 37100 VERONA (VR): DALLA CORTE RINO
 IYU 37036 S. MARTINO B. ALB. (VR): MAZ MER
 IYV 37100 VERONA (VR): PASQUETTO MARIO
 IYW 37020 ARBIZZANO (VR): RIGHETTI RINALDO
 IYX 37030 COLOGNOLA COLLI (VR): DREZZA GIOVANNI OFF. DIESEL
 IYY 37063 ISOLA DELLA SCALA (VR): MANTOVANI & BISSOLI
 IYZ 46043 CASTIGLIONE D. STIV.: MARCHI BRUNO

Z

IZA 46040 CURTATONE (MN): F.B. DI BRESCIANI A. & F.
 IZB 46025 POGGIO RUSCO (MN): BERGAMINI ONELIO
 IZC 46044 GOITO (MN): TARASCHI ANTONIO
 IZD 37053 CERE A (VR): OFF. MIRANDOLA VEIC. IND.
 IZE 37044 COLOGNA VENETA (VR): ROSSIN SILVANO OFF. ELLETR.
 IZG 37050 FALU (VR): PIRANA ROBERTO
 IZH 37038 SOAVE (VR): GUIDOLINI ROBERTO
 IZI 37067 VALEGGIO SUL MINCIO (VR): TARASCHI ALBERTO

6. ITALIEN, ITALY, ITALIE, ITALIA, ITALIA,



Z

IZJ 38100 TRENTO (TN): TOMAR DI TOMEDI MARCO
IZK 38014 GARDOLO (TN): TECNO DIESEL INIEZ. DI GIRAR
IZL 38065 MORI (TN): BERTOLINI ARNALDO
IZM 38057 PERGINE (TN): TECNODIESEL DI MOTTESI E.
IZN 38068 ROVERETO (TN): TECNODIESEL SNC DI MARANELLI
IZO 38068 ROVERETO (TN): SENTER ITALO ELETTRAUTO
IZP 38100 TRENTO (TN): STECH ALDINO
IZR 46100 MANTOVA (MN): URBANI VITTORIO

6. ITALIEN (2), ITALY (2), ITALIE (2), ITALIA (2), ITALIA (2),



A

KAA 35138 PADOVA (PD): BACCELLE ELETTR. SNC
KAB 35020 CAMIN (PD): AUTOFF. ANTONIANA DI DALAN F.
KAC 35123 PADOVA (PD): OFF. MUGA - BENETELLO
KAD 35121 PADOVA (PD): MODULO F.LLI SNC DI G. & R.
KAE 35135 PADOVA (PD): PERUZZO GINO ELETTRDIESEL
KAF 35136 PADOVA (PD): BENVOLUTI LORENZO OFF. ELETT.
KAG 35013 CITTADELLA (PD): SEGNA ULTIMO & FIGLI SPA
KAH 35137 PADOVA (PD): BORTOLAMI FRANCESCO
KAK 35129 PADOVA (PD): MARETTO LORENZO ELETTR.
KAL 35010 CADONEGHE (PD): MIELE FRANCO
KAM 35044 MONTAGNANA (PD): GIACOMINI REMO & C. SNC
KAN 35100 PADOVA (PD): BELLUCCO ORESTE & C. SNC
KAO 32014 PONTE NELLE ALPI (BL): ALPI CAR SNC
KAP 32100 BELLUNO (BL): ELETTR. VIEL M. & F.LLI SNC
KAR 35020 MASERA' (PD): TECNO-DIESEL SNC
KAS 45100 ROVIGO (RO): PREVIATO GIORGIO ELETTR.
KAT 39100 BOLZANO (BZ): EISATH JOSEF & C.
KAV 45100 ROVIGO (RO): F.LLI BERTO SNC ELETTRAUTO
KAW 45019 TAGLIO DI PO (RO): MORETTO A. ELETTR. RICAMBI
KAX 45100 ROVIGO (RO): FORTUNATI OTTORINO SNC
KAZ 31100 TREVISO (TV): DE MARCHI ANGELO

B

KBA 31033 CASTELFRANCO VENETO (TV): ROCCOBERTON FRANCO & C. SNC
KBB 31015 CONEGLIANO (TV): FEDOL F.LLI SPA
KBC 31037 LORIA (TV): ARTUSO F.LLI SNC
KBD 31044 MONTEBELLUNA (TV): ALBANESE FERNANDO
KBE 31053 PIEVE SOLIGO (TV): ARMELLIN & BARAZZA SNC
KBF 31010 PONTE PRIULA (TV): BARDI PIETRO ELETTRORICAMBI
KBG 31028 VAZZOLA (TV): MORAS B. LINO ELETTR.
KBH 31050 VILLORBA (TV): ATTOMBRI GIANNI
KBI 31044 MONTEBELLUNA (TV): AUTOSHOP BEPI
KBJ 31045 MOTTA DI LIVENZA (TV): MARCHESIN CARLO
KBM 33100 UDINE (UD): NUOVA ELETTRDIESEL SNC
KBN 30174 ZELARINO (VE): FRANZOI DINO ELETTR.
KBO 30172 MESTRE (VE): ELETTR. VESCOVI A.
KBP 30026 PORTOGRUARO (VE): CAPPELLOZZA GIUSEPPE
KBR 30027 SAN DONA PIAVE (VE): AUTOEMPORIO DI MAMERTI G.
KBS 30025 NOVENTA PIAVE (VE): ELETTR. DI CAGNIN B. & C.
KBT 30030 FAVARO VENETO (VE): ANTONELLO GIORGIO
KBW 36060 ROMANO D'EZZELINO (VI): F.LLI FARINA S.L. & C. SAS
KBX 36061 BASSANO DEL GRAPPA (VI): TASCA CLAUDIO ELETTRAUTO
KBY 36078 VALDAGNO (VI): ROSSATO ANTONIO ELETTR.
KBZ 36061 BASSANO DEL GRAPPA (VI): BASSANO DIESEL F.LLI MICHELO



C

KCA 36031 DUEVILLE (VI): BAU' ERMELINDO ELETTR.
 KCB 36063 MAROSTICA (VI): OFF. STRADA SRL
 KCC 36024 PONTE DI NANTO (VI): DAL BARCO GIUSEPPE OFF. ELETTR.
 KCD 36027 ROSA' (VI): BIZZOTTO GIOVANNI ELETTR.
 KCE 36028 ROSSANO VENETO (VI): TREVISAN ANTONIO
 KCF 36016 THIENE (VI): GALLO ADAICLA ELETTR.
 KCG 36050 CARTIGLIANO (VI): TOMMASI GIUSEPPE ELETTR.
 KCH 35129 PADOVA (PD): VERARDINI A. SAS
 KCI 35025 CARTURA (PD): MENEGHELLO ENRICO & C. SNC
 KCJ 35013 CITTADILLA (PD): BILLATO & VAROTTO SNC OFF.
 KCK 35044 MONTAGNANA (PD): ORPI DI PICCOLO M.
 KCL 35028 PIOVE DI SACCO (PD): CONTESSO GIOCONDO
 KCM 35028 PIOVE DI SACCO (PD): F.LLI ROCCO SNC
 KCN 32100 BELLUNO (BL): ROSSA GIOVANNI OFF. DIESEL
 KCO 32032 ANZU'DI FELTRE (BL): FIZZOLON CARLO OFF. DIESEL
 KCP 45011 ADRIA (RO): O.M.F.I.
 KCR 45030 OCCHIOBELLO (RO): NOVADIESEL DI TIMACCHI G.
 KCS 31100 TREVISO (TV): P.I.B.O. DI BOTTAZZO B.
 KCT 31100 TREVISO (TV): PICCIOL ARIOSTO
 KCU 31020 SAN VENDEMIANO (TV): TRONCON F.LLI A. & R. SNC
 KCV 31030 BIADENE/MONTEBELLUNA: PASQUALIN & ARMELLIN SNC
 KCW 31046 ODERZO (TV): ZECCHINELLO ILLARIO S. DIES.
 KCX 30033 MALCONTENTA (VE): OFF. DIESEL GHESINI SNC
 KCY 30175 MARGHERA (VE): PAULETTO MOSE' SNC OFF. DIESEL
 KCZ 30171 MESTRE (VE): AUTOSERVICE SNC DI NIERO

D

KDA 30027 SAN DONA PIAVE (VE): BARUZZO & MION SNC
 KDB 30019 SOTTOMARINA (VE): FERRARA EUGENIO OFF. SPECIAL
 KDC 35025 FOSSALTA (VE): GIUSTO LUIGINO OFF. MECC.
 KDD 36034 MOLINA DI MALO (VI): SALVIO SERGIO ELETTR.
 KDE 36041 ALTE CECCATO (VE): MERIGA LUIGI & C. SNC
 KDF 36075 MONTECCHIO MAGGIORE: GASPARINI GIORGIO & C. SNC
 KDG 36040 VANCIMUGLIO (VI): BEDIN GUIDO RIPARAZIONE POMP
 KDH 32032 FELTRE (BL): ELETTR. CASTELLI SNC
 KDI 35127 PADOVA (PD): LAR DI CHILIN GILBERTO
 KDJ 35010 CADONEGHE (PD): G.R.S. SNC DI SCANFERLA G.
 KDK 35025 CARTURA (PD): SUMAN CARLO ELETTRAUTO
 KDM 30020 PRADIPOLZO/PORTOGRUARO: ZIFATINI ANTONIO & FRANCESCO
 KDO 35132 PADOVA (PD): PIOTTO ADRIANO ELETTRAUTO
 KDP 35133 PADOVA (PD): ZANON M. & F.
 KDR 45100 ROVIGO (RO): RAULI S. & RONDINA E. SNC
 KDS 35013 CITTADILLA (PD): VISENTIN ELETTRAUTO SRL
 KDT 45021 BADIA POLESINE (RO): ELETTRAUTO BERNARDINELLO BRU
 KDU 31010 GODEGA S. URBANO (TV): MAZZUCCATO GIANCARLO
 KDV 45021 BADIA POLESINE (RO): SANTACATERINA EZIO SERV. ELE
 KDW 45019 TAGLIO DI PO (RO): ANDREOLLI GERMANO OFF. DIESEL
 KDX 31044 MONTEBELLUNA (TV): ROMANAZZI FRANCESCO AUTODIESEL
 KDY 30170 MESTRE (VE): MANENTERINO & C. SNC
 KDZ 30018 NOALE (VE): FAVARETTO GIUSEPPE OFF. DIESEL

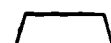

E

KED 36025 NOVENTA VICENTINA (VI): MAZZUCCATO LEONZIO OFF. ELETTR.
 KEF 36073 SPAGNAGO DI CORNEDEO (VI): FIN GIANNI ELETTRAUTO
 KEG 31010 ONE' DI FONTE (TV): F.LLI MAZZAROLO
 KEH 36100 VICENZA (VI): ELETTRDIESEL DI ROSSI & FIG.
 KEI 36028 ROSSANO VENETO (VI): STRAGLIOTTO G. ELETTRAUTO
 KEJ 33050 TORVISCOSA (UD): MOTORTECNICA SNC DI CULOS G.
 KEK 33017 TARCENTO (UD): MININI GIOVANNI
 KEL 36012 ASIAGO (VI): CENTRO DIESEL ASIAGO
 KEM 45100 ROVIGO: FORTUNATI DI FORTUNATI P.

F

KFA 33030 OSPEDALETTO DI GEMONA: OFF. DEL DIESEL DI DI GIUSTO
 KFC 33100 UDINE (UD): VICARIO IVO
 KFE 33028 TOLMEZZO (UD): ELETTRDIESEL F.LLI FIOR SNC
 KFF 33019 TRICESIMO (UD): CUBERLI CARLO
 KFH 33052 CERVIGNANO D. FRIULI: AUTOELETTRIK DI IACCUZZO
 KFI 33044 MANZANO (UD): ALTOBELLI VINCENZO
 KFL 33043 CIVIDALE (UD): FRIULCAR CIVIDALE SNC
 KFM 33100 UDINE (UD): MARANZANA F.LLI SNC
 KFN 33100 UDINE (UD): FECILE ARTEO
 KFO 33054 LIGNANO SABBIA D'ORO (UD): TORRESAN LIVIO & C. SNC
 KFR 34074 MONFALCONE (GO): DELFIN GODEASSI A. & C. SNC
 KFS 34170 GORIZIA (GO): ELETTRAUTOVONCINA
 KFT 33170 PORDENONE (PN): DE LUCA S.P.A.
 KFU 33081 AVIANO (PN): MAZZOCCO GIOVANNI & PIERLUIGI
 KFV 33097 SPILIMBERGO (PN): GIACOMELLO SANTE
 KFW 33170 PORDENONE (PN): COLUSSI SNC AUTOELETTRONICA
 KFX 33170 PORDENONE (PN): TECNODIESEL DI SALOMON ANGEL
 KFY 34135 TRIESTE (TS): PLANINE LIVIO
 KFZ 34100 TRIESTE (TS): AUTOF. VALMAURA

G

KGA 34137 TRIESTE (TS): BILLA GIGI
 KGC 34148 TRIESTE (TS): TECNOELETTRDIESEL SNC DI GO
 KGD 16035 RAPALLO (GE): TESSERA CRISTOFORO & C.
 KGE 33050 CASTION DI STRADA (UD): MASUTTI GIUSEPPE
 KGF 33080 ROVEREDO IN PIANO (PN): CASARI & BONETTO SNC
 KGG 33077 SACILE (PN): MARCON DOMENICO
 KGH 33081 AVIANO (PN): TASSAN GIORDANO & C. SNC
 KGI 33050 MORTEGLIANO (UD): TURLONI ANTONIO
 KGJ 34076 ROMANS D'ISONZO (GO): DE MARCHI LUCIANO
 KGK 33077 SACILE (PN): COLOMBERA ARISTIDE
 KGL 34019 SISTIANA (TS): MIDENA PIRAN ELETTRAUTO



H

KHA 39100 BOLZANO/BOZEN (BZ): OFF. DELL'AGRIZZO
 KHB 39100 BOLZANO/BOZEN (BZ): MOCK G. ELETTRAUTO
 KHC 39057 APPIANO/EFFAN (BZ): TRETTL KLAUS
 KHD 39031 BRUNICO/BRUNECK (BZ): GROEHE MARTIN-ELETTRODIESEL
 KHE 39022 LAGUNDO/ALGUND (BZ): GRAZIADEI HELMUT
 KHF 39011 LANA D'ADRIGE (BZ): PLUNGER RUDOLF
 KHG 39012 MERANO/MERAN (BZ): RATSCHILLER ADOLF
 KHH 39028 SILANDRO (BZ): MOSER ARNOLD
 KHI 39049 VIPITENO/STERZING (BZ): UNTERTHINER ALOIS
 KHJ 39040 BARBIANO (BZ): RABANSER GUENTHER & C. SNC
 KHK 39100 BOLZANO/BOZEN (BZ): GASPARINI & MICHELOTTI
 KHL 39100 BOLZANO/BOZEN (BZ): PFEIFER ULRICH
 KHM 47040 CORIANO (FO): VISERBI GIOVANNI

I

KIA 16161 GENOVA-RIVAROLO (GE): RONCALLO G.B. ELETTR.
 KIB 16043 CHIAVARI (GE): ELETTRAUTO LIGURE
 KIC 16043 CHIAVARI (GE): SEMORILE & BELDI SNC
 KID 16149 GENOVA-SAMPIERDARENA: L'ARTIGIANA DI FACCHETTI G.
 KIE 16121 GENOVA (GE): GUERRA GIOVANNI
 KIF 16129 GENOVA (GE): ELETTRA DI MUSSO. L. & C.
 KIG 16129 GENOVA (GE): OTTAVI SAS DI BOERO A. & G.
 KIH 16039 SESTRI LEVANTE (GE): GRANDI GIOVANNI
 KII 34010 SGONICO (TS): VODOPIVEC GIOVANNI
 KIJ 16011 ARENZANO (GE): AUTONAUTICA SNC A. E C.
 KIK 16121 GENOVA (GE): PROVVIDO & GRAMOLELLI SDF
 KIL 16152 GENOVA-CORNIGLIANO (GE): ELETTRAUTO ERIDANIA
 KIM 16149 GENOVA-SAMPIERDARENA: ELETTRODIESEL DI CAMPANINI F.
 KIO 19100 LA SPEZIA (SP): PASQUALI LUIGI ELETTR.
 KIP 16128 GENOVA (GE): ELETTR. CARIGNANO SNC
 KIS 16149 GENOVA-SAMPIERDARENA: AUTODIESEL SNC
 KIT 16161 GENOVA-BOLZANETO (GE): SERVIZIO DIESEL DI LORI
 KIU 19037 SANTO STEFANO DI MAGRA: PINI SERGIO
 KIV 16146 GENOVA (GE): INFINITY SOUND SNC
 KIW 16132 GENOVA (GE): ELETTRAUTO EUGENIO DI MAGNAN
 KIX 16161 GENOVA-RIVAROLO (GE): PEDEMONTE E.-DIESEL SERVICE
 KIY 16149 GENOVA-SAMPIERDARENA (GE): ELETTR. SDF LA MARCA & SCIAL
 KIZ 16151 GENOVA-SAMPIERDARENA (GE): ELETTR. CARPI MARIO

K

KKB 17014 CAIRO MONTENOTTE (SV): ELETTRODIESEL
 KKD 17025 LOANO (SV): CASELLA STEFANO
 KKE 17045 LEGINO (SV): NERVI ELVIO
 KKF 17031 ALBENGA (SV): GARRIONE FLAVIO
 KKI 18100 IMPERIA (IM): VASSALLO VINCENZO
 KKJ 17100 SAVONA (SV): VIVALDI EZIO
 KKK 17045 LEGINO (SV): F.LLI MORELLO SNC
 KKL 18100 IMPERIA (IM): OFF. MONTANARI DI FERNANDO &
 KKM 18100 IMPERIA (IM): MONTISSORI & MUSSO SDF

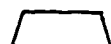

K

KKR 17031 ALBENGA (SV): ELETTRODIESEL VIGNOLA L. & c.

L

KLA 40127 BOLOGNA (BO): BARBIERI FRANCESCO
 KLC 40138 BOLOGNA (BO): TOP SERVICE CAR
 KLD 40128 BOLOGNA (BO): F.LLI FIUMI
 KLE 40129 BOLOGNA (BO): LUCCHI FIER PAOLO
 KLF 47100 FORLI': NUOVA COEM
 KLG 40131 BOLOGNA (BO): TINTI ENRICO & C. SDF
 KLH 40033 CASALECCHIO R. (BO): FOLI ANTONIO
 KLI 40013 CASTEL MAGGIORE (BO): VIGNOLI PAOLO
 KLJ 40014 CREVALCORE (BO): MATTIOLI SOLIERI & PRETI SNC
 KKK 40026 IMOLA (BO): DAL FIUME & MONDUZZI F.
 KLL 40037 SASSO MARCONI (BO): BALLA DINO
 KLN 40136 BOLOGNA (BO): TINTI ROBERTO
 KLO 40127 BOLOGNA (BO): BALDI V. & GOVONI F.
 KLP 40063 MONGHIDORO (BO): GIRONI GIANCARLO
 KLR 40046 PORRETTA TERME (BO): NANNI DI NANNI N. & r. F.LLI
 KLS 40068 SAN LAZZARO (BO): FERLINI & MAZZA SNC
 KLT 40015 SAN VINCENZO GALLIERA: TESTONI CARLO
 KLU 40051 ALTEDO (BO): TUGNOLI ANDREA
 KLV 40053 BAZZANO (BO): ELETTR. B.B. DI BIAGINI
 KLW 40017 SAN GIOVANNI IN PERS.: VECCHI & BOMORA SNC
 KLY 40139 BOLOGNA (BO): MINELLI & FRONZONI
 KLY 40122 BOLOGNA (BO): TURRINI BRUNO
 KLZ 40011 ANZOLA EMILIA (BO): ELETTROMECCANICA SNC DI STANZANI A.

M

KMA 40035 CASTIGLIONE DEI PEPOLI: PARISINI MARTINO
 KMC 47100 FORLI (FO): BERARDI VITTORIO ELETTR. & C.
 KMF 44100 FERRARA (FE): BERTI & C. SNC ELETTRODIESEL
 KMG 47100 FORLI (FO): ELETTRODIESEL SNC
 KMH 44100 FERRARA (FE): SITTA SNC ELETTRAUTO
 KML 40138 BOLOGNA (BO): ZANOLINI & FABBRI
 KMM 44022 COMACCHIO (FE): BELLOTTI WILLIAM & LORIS
 KMN 44020 GALLO (FE): ZERBINI UGO
 KMO 44037 IOLANDA SAVOIA (FE): FERRO IVANO
 KMP 40010 BENTIVOGLIO (BO): MAZAN ELETTR. DI MAZZARIELLO
 KMR 44015 FORTOMAGGIORE (FE): GIACOMETTI VALERIO
 KMS 44100 FERRARA (FE): RIGHETTI CLAUDIO
 KMT 44100 FERRARA (FE): CAVICCHI LUCIANO
 KMU 47037 RIMINI (FO): COMEL FILIALE
 KMV 47023 CESENA (FO): PIRINI CASADEI QUINTO & C.
 KMW 47040 VILLA VERRUCCHIO (FO): F.LLI CINARELLI
 KMX 47047 MORCIANO (FO): VILLA ENZO
 KMY 48100 PONTE NUOVO RAV. (RA): PIOVAN GIANCARLO
 KMZ 47023 CESENA (FD): CUCCHI NINO

6. ITALIEN (2), ITALY (2), ITALIE (2), ITALIA (2), ITALIA (2),



N

KNA 47100 FORLI (FO): BENZOATI AUGUSTO
 KNB 47037 RIMINI (FO): LORENZI A. & ZAGHINI M. SNC
 KNC 40026 IMOLA (BO): PIRAZZOLI BATTISTA & C. SNC
 KND 47044 IGEA MARINA (FO): VENTURINI & ZANNONI
 KNE 40060 OSTERIA G. (BO): DONDI SILVANO & C. SNC
 KNF 40050 MONTEVEGLIO (BO): F.V. SNC DI FECCHIO & VOLPEL
 KNG 40050 CASTELLO D'ARGILE (BO): ORSI FRANCESCO
 KNH 47042 CESENATICO (FO): SAVINI MARIO & C.
 KNJ 40040 RIOVEGGIO (BO): LENZI EZIO
 KNK 47014 MELDOLA (FO): R.C.T. SNC TASSANI & RUFFILLI
 KNL 47045 MIRAMARE (FO): NUOVA ELETT. CARLINI R.
 KNN 47036 RICCIONE (FO): BETTI RICCARDO
 KNO 40037 SASSO MARCONI (BO): COSMO DIESEL DI MAGLIANO COS.
 KNP 47037 RIMINI (FO): MEZZENA FEDERICO
 KNR 47038 S.ARCANGELO R. (FO): BARDUCCI ANTONIO
 KNT 48100 RAVENNA (RA): VAROLI GIUSEPPE DI PASCOLI P.
 KNU 48011 ALFONSINE (RA): F.LLI CAMANZI & C. SNC
 KNV 47033 CATTOLICA (FO): ELETTRONIC AUTO DI F. VALUBB.
 KNX 48022 LUGO (RA): ZANI F.LLI BRUNO & SERGIO SNC
 KNY 47036 RICCIONE (FO): PRO-RA-MA DI PROTTI
 KNZ 48015 CERVIA (RA): CONTI & CAVALLUCCI

O

KOA 40062 MOLINELLA (BO): F.LLI REZZAGHI O. & L. SNC
 KOB 48018 FAENZA (RA): AVVEDUTI LIVIO
 KOC 48100 RAVENNA (RA): MAZZOTTI DANTE
 KOD 40131 BOLOGNA (BO): MAZZA BRUNO & C.
 KOE 40068 S.LAZZARO DI SAVENA (BO): RUBINI SNC DI RINDO & S.
 KOF 40138 BOLOGNA (BO): VENTUROLI ERMINIO SNC
 KOG 40129 BOLOGNA (BO): F.LLI CESARI SNC
 KOH 40024 CASTEL S. PIETRO (BO): CASSADIO LORETI G. & C. SNC
 KOI 47100 FORLI': CASADEI ELIO & ROSSI STELIO
 KOJ 40017 S.GIOVANNI IN PERS.: CORTESI GIUSEPPE & C. SNC
 KOK 40127 BOLOGNA (BO): SERVIZIO DIESEL
 KOL 40026 IMOLA (BO): EURODIESEL SRL
 KON 40131 BOLOGNA (BO): MAZZOLI GINO & C.
 KOO 40033 CASALECCHIO R. (BO): PARAZZA & MASELLI
 KOP 40013 CASTEL MAGGIORE (BO): ZANARINI ORIO
 KOR 44011 ARGENTA (FE): CONSTANTINI G. & C.
 KOS 40060 TOSCANELLA DI DOZZA (BO): R.L. DI RONCHI A. & LUGHINI
 KOT 44042 CENTO (FE): DIESEL CAR - D'ALTERIO
 KOU 44021 CODIGORO (FE): SERRA DANTE & C. SNC
 KOV 47023 TORRE/MORO CESENA (FO): OFF. BIANCHI DI BIANCHI & C.
 KOW 47037 RIMINI (FO): BARBANTI VINCENZO
 KOX 47037 RIMINI (FO): TONINI ENRICO & ANDREA S.D.F.
 KOY 47037 RIMINI (FO): UGOLINI F. & C. SNC
 KOZ 47048 SAN GIOVANNI MARIGNANO: GESSI GIOVANNI

F 21

E. ITALIEN (2), ITALY (2), ITALIE (2), ITALIA (2), ITALIA (2),

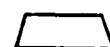

P

KPA 48100 RAVENNA (RA): BACCILOLO GIULIANO & C. SNC
 KPB 48018 FAENZA (RA): NUOVA DIESEL INIEZIONE FAENZ
 KPC 48022 LUGO (RA): GUARNIERI & BABINI
 KPD 48018 FAENZA (RA): FAENZA DIESEL DI BAGNOLINI R.
 KPE 44100 FERRARA (FE): ROVERI GIULIANO
 KPF 44034 COPPARO (FE): MALAGUTTI G. & G. SNC
 KPG 47100 FORLI (FO): ELETTR. ROBERTO DI TASSINARI
 KPH 47034 FORLIMPOPOLI (FO): S.E.F.O.R. SNC
 KPI 48014 CASTEL BOLOGNESE (RA): ASSIRELLI GIANCARLO
 KPJ 42016 GUASTALLA (RE): PONTIROLI & SIMONAZZI

R

KRA 41100 MODENA (MO): BOTTI & C.
 KRB 41100 MODENA (MO): ELETTR. AMENDOLA DI GAVIOLI
 KRC 41100 MODENA (MO): G.E.M. SNC DI LUGLI DORANDO
 KRD 41100 MODENA (MO): ELETTRAUTO GIARDINI
 KRE 41100 MODENA (MO): GUERZONI & FRANCHINI
 KRF 41100 MODENA (MO): ORLANDINI PIETRO
 KRH 41030 BOMFORITO (MO): SACCHETTI GIORGIO
 KRI 41012 CARPI (MO): ELETTRAUTO BELTRAMI
 KRJ 41012 CARPI (MO): VALENTINI LEO & ALBERTO
 KRK 41100 MODENA (MO): SEGHEDONI WILLIAM
 KRL 41013 CASTELFRANCO E. (MO): ELETTRAUTO GMT
 KRM 41013 CASTELFRANCO E. (MO): FREGNI SILVIO & C.
 KRN 41014 CASTELVETRO (MO): LEONARDI VALENZO
 KRO 41019 SOLIERA (MO): MANFEDINI CELSO
 KRP 41043 FORMIGINE (MO): BRAGLIA LUCIANO
 KRR 41012 CARPI (MO): MUSSINI GUIDO OFF. MECCANICA.
 KRT 41053 MARANELLO (MO): LUMETTI SNC DI LUMETTI M.G.
 KRU 41037 MIRANDOLA (MO): GASPARINI NORBERTO & AGOSTIN
 KRV 41046 PALAGANO (MO): TEGGI LORENZO
 KRW 41026 PAVULLO (MO): FONTANAZZI & ROGGIANI SDF
 KRX 41012 CARPI (MO): PIVETTI GIANCARLO
 KRY 41100 MODENA (MO): PARENTI G. & C.
 KRZ 41017 RAMI RAVARINO (MO): LODI VITTORIO

S

KSA 41012 CARPI (MO): AUTOCENTRO CARPI GAS
 KSB 41030 PROSPERO (MO): CAVICCHIOLI ALBERTO
 KSC 41056 SAVIGNANO (MO): BONFIGLIOLI MARIO
 KSD 41037 S. GIACOMO RONCOLE (MO): REBUCCI DANTE
 KSE 41039 SAN POSSIDONIO (MO): MARCHESI ALBERTO
 KSF 41056 SAVIGNANO (MO): MORISI F.LLI ELETT.
 KSG 41100 MODENA (MO): CENTRO DIESEL DI JANNELLO E.
 KSH 41049 SASSUOLO (MO): ELETT. BF-BENASSATI FRANCHI
 KSI 41011 CAMPOGALLIANO (MO): AUTO TIR SNC DI BONACCINI C.
 KSJ 41051 CASTELNUOVO RANGONE (MO): TEDESCHINI & C. SDF
 KSK 41049 SASSUOLO (MO): MONTAGNANI & MUSSINI
 KSL 41032 CAVEZZO (MO): MANFREDINI JAGO

F 22

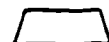

S

KSM 41049 SASSUOLO (MO): BERSELLI RICCARDO
 KSN 41100 MODENA (MO): COCCHI TONINO
 KSD 41100 MODENA (MO): CDA DI ZANASI RINO & C.
 KSP 41037 QUARANTOLI MIR. (MO): PARENTI GIUSEPPE
 KSR 41058 VIGNOLA (MO): MIGLIORI ADELMO
 KST 42100 REGGIO EMILIA (RE): MONTERMINI ADRIANO
 KSU 41049 SASSUOLO (MO): PASSINI GIULIANO OFF. DIESEL
 KSV 42013 CASALGRANDE (RE): ELETTRAUTO IVAN FERRARI
 KSW 42034 CASINA (RE): VALLI PIETRO & EDEN
 KSX 42026 CIANO D'ENZA (RE): OFF. ELETTR. F.LLI MONTANARI
 KSZ 42013 SAN MARTINO IN RIO (RE): ROSSI FRANCO

T

KTA 42100 REGGIO EMILIA (RE): GRASSI GIANFRANCO
 KTB 42100 REGGIO EMILIA (RE): GOVI FERRARI & C. SNC
 KTC 42100 REGGIO EMILIA (RE): BERTOLINI-FANTUZZI & C. SNC
 KTD 42035 CASTELNUOVO NE' MONTI: C.E.A.A. SNC DI BIZZARRI
 KTE 42048 RUBIERA (RE): NUOVA POMPE INIETTORI SNC
 KTG 42100 REGGIO EMILIA (RE): BAGNACANI ADAMO
 KTH 42100 REGGIO EMILIA (RE): SALA & BENASSI
 KTI 42100 REGGIO EMILIA (RE): BERTOLI DONATO
 KTJ 42100 REGGIO EMILIA (RE): CARBOGGNO PRIMO & C.
 KTK 42014 CASTELLARANO (RE): CECCHINI & CASOLARI & C. SNC
 KTL 42015 CORREGGIO (RE): ELETTRAUTO INCERTI A.
 KTM 42017 NOVELLARA (RE): TONDELLI ANILLO ELETTR.
 KTN 42016 GUASTALLA (RE): BERTELLE DOLIO ELETTRAUTO
 KTP 41100 MODENA (MO): ELETTRODIESEL EMILIA
 KTR 41100 MODENA (MO): DIESELELETTR. DI VERZELLONI
 KTS 41012 CARPI (MO): REBECCHI ALBERTO
 KTT 41034 FINALE EMILIA (MO): FERRARI LODOVICO & RENZO SNC
 KTU 41037 MIRANDOLA (MO): OSDA DI BERGAMINI G.
 KTV 41026 PAVULLO (MO): BENEDETTI F.LLI DI F. & G.
 KTW 41049 SASSUOLO (MO): LODESANI GIORGIO
 KTX 41058 VIGNOLA (MO): SANDRINI DI CAVEDONI CORNI &
 KTY 41057 SPILAMBERTO (MO): DIESEL STAR DI BERGAMINI L.
 KTZ 42100 REGGIO EMILIA (RE): RUSTICHELLI DI M.F. & C.

U

KUA 42017 NOVELLARA (RE): VERONI EMANUELE
 KUB 42048 RUBIERA (RE): BOCCOLARI ANGELO & C. SNC
 KUD 42100 REGGIO EMILIA (RE): LENZI & BASENGHI SNC
 KUE 42100 REGGIO EMILIA (RE): REGGIO INIEZIONE DI FELICI C.

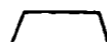

W

KWA 43100 PARMA (PR): ATTOLINI G. & W. SNC
 KWB 43100 PARMA (PR): BONAZZI GIANCARLO SNC
 KWC 43100 PARMA (PR): BUCCI GUIDO DI LUCIANO
 KWD 43043 BORGOTARO (PR): LARINI BRUNO
 KWE 43024 CAMFORA (PR): BALDI F.LLI SNC
 KWF 43052 COLORNO (PR): ELETTR. MOTOR SNC
 KWG 43035 FELINO (PR): SPAGGIARI FLAVIO
 KWH 43036 FIDENZA (PR): DALL'AGLIO CLAUDIO
 KWI 43017 SAN SECONDO FARMENSE: VOLPI SERGIO
 KWK 43058 SORBOLO (PR): ZIBANA BONFIGLIO
 KWL 43010 ZIBELLO (PR): CAFORALI GIAN MARIO
 KWM 43011 BUSSETO (PR): P.M.T. ELETTR. MECCANICA SNC
 KWN 43013 LANGHIRANO (PR): G.R.G. DI GHIRETTI F.LLI
 KWO 43010 PONTE TARO (PR): CAVAGNA RENATO
 KWP 43045 FORNOVO DI TARO (PR): ELETTR. F.LLI FELANI
 KWR 43015 NOCETO (PR): ARTONI CARLO
 KWS 43044 COLLECCHIO (PR): SONCINI GUIDO
 KWT 43100 PARMA (PR): VALENTI PRIMO
 KWU 43100 PARMA (PR): ELETTR. SPOTTI DI BOTTI G. &
 KWV 43100 PARMA (PR): ELETTR. SPOTTI DI BOTTI G. &
 KWY 43100 PARMA (PR): COPELLI DI COPELLI & C.

X

KXA 43036 FIDENZA (PR): BRACCHI & VESCOVI SNC
 KXB 29100 PIACENZA (PC): AUTOFFICINA PIACENZA
 KXC 29100 PIACENZA (PC): ROSSI ELETTRAUTO DI ROSSI CA
 KXD 29010 ROVELETO CADEO (PC): S.B.P. DI PEZZONI & C. SNC
 KXE 29013 CARPANETO PIACENTINO (PC): AUTOTECHNICA DI BARBIERI A.
 KXF 29014 CASTELL'ARQUATO (PC): RICORDA PIERGIORGIO
 KXG 52027 SAN GIOVANNI VALDARNO: MARIANI AUTOELETTR.
 KXH 43100 PARMA (PR): DIESEL PARMA
 KXI 43100 PARMA (PR): GHIRETTI & TALIGNANI
 KXJ 43036 FIDENZA (PR): MICHELETTI BRUNO & G. SNC
 KXK 43100 PARMA (PR): OPPICI & ZONI ELETTR. SNC
 KXL 43100 PARMA (PR): RONCONI GIANFRANCO
 KXM 43100 PARMA (PR): BERTOLINI GIORGIO
 KXN 29100 PIACENZA (PC): MERLINI & FAVA
 KXO 29015 CASTEL S. GIOVANNI (PC): DADA' G. FRANCO
 KXP 29017 FIORENZUOLA D'ARDA (PC): O.F.R.A. SNC

Y

KYB 29010 SAN NICCOLO TREBBIA (PC): NEGRATI ROBERTO
 KYC 29010 ROVELETO CADEO (PC): VENEZIANI LUIGI & C. SNC
 KYD 29100 PIACENZA (PC): PODESTA' SNC DI PODESTA' & M.
 KYE 29100 PIACENZA (PC): PERDONI & LUSARDI SNC
 KYF 50060 SAN ELLERO (FI): MORANDI EUGENIO ELETTR. DIESEL
 KYG 50019 OSMANNORO S.F. (FI): TOSCODIESEL SNC DI MORETTI M.
 KYH 29015 CASTEL S. GIOVANNI (PC): GENNARI ANGELO
 KYI 53042 CHIANGIANO TERME (SI): AUTOFFICINA RINASCENTE

6. ITALIEN (2), ITALY (2), ITALIE (2), ITALIA (2), ITALIA (2),



Y

KYN 43100 PARMA (PR): ELETTROPARMA SNC
KYP 33030 CAMPOFORMIDO (UD): ARA S.P.A.
KYR 16039 SESTRI LEVANTE (GE): ANTONUCCI IZIANO

Z

KZA 50144 FIRENZE (FI): ALINARI RENATO
KZD 52040 AREZZO/OLMO (AR): O.R.P.I. SNC DI BURRONI & C.
KZE 50145 FIRENZE (FI): OSMANO ELETTRODIESEL
KZG 50045 MONTEMURLO (FI): T.A.E.D.
KZH 50053 EMPOLI (FI): LANDI ILIANO
KZI 50045 MONTEMURLO/OSTE (FI): O.R.E.P. SNC
KZJ 52100 AREZZO (AR): BENOCCI F.LLI
KZL 50047 PRATO (FI): FATANTI PAOLO & CARLO
KZM 50047 PRATO (FI): AUTOEL. MODERNA DI NARDI R.
KZN 52100 AREZZO (AR): OFF. DIESEL DI NERI, M., G.,
KZO 50142 FIRENZE (FI): GALLAI S.D.F.
KZR 50121 FIRENZE (FI): MELANI ROTILIANO ELETTRAUTO
KZS 29017 FIORENUOLA (PC): PIZZELLI & TURNI
KZT 50127 FIRENZE (FI): PROFESSIONAL CAR SRL
KZU 50053 EMPOLI (FI): ELETTRODIESEL FRA. RE SNC
KZW 50040 CANTAGALLO (FI): OFF. ELETTROD. DI NEGRI G.
KZX 50047 PRATO (FI): AUTOTURBODIESEL DI LUPOLI E.
KZY 50026 S. CASCIANO V. DI PESA: BIANCHI & PESTELLI
KZZ 50020 PANZANO IN CHIANTI (FI): GAMBASSI MARIO

6. FINNLAND, FINLAND, FINLANDE, FINLANDIA, FINLANDIA,

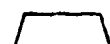

A

LAS AMMÄNSAARI: YLÄ-KAINUUN AUTOSÄHKÖ, VOIMAKATU 3

A

LAL ALAVUS: DIESELKORJAUS V. HAHTOLA, KALLENKUJA 3
LAM ALAJARVI: AUTOSÄHKÖ ARVO MÄNNIKKÖ, KUREJOKI

B

LBS JYVÄSKYLÄ: B. SENILÄ-DIESEL KY, PÄÄSKYNTIE 3

F

LFO FORSSA: FORSSAN SÄHKÖDIESEL, HÄMEENTIE 41

H

LHA HÄMEENLINNA: HÄMEEN DIESEL OY, MÄKELÄNTIE 16
LHA HARJAVALTA: AUTOKORJAAMO MAURI MÄNNISTÖ, SAIRAALANTIE 31
LHB HELSINKI: OTEKO OY, KARJALANKATU 2
LHC HELSINKI: AUTOSÄHKÖ CITY OY, KARJALANKATU 2
LHD HEINOLA: DIESELPISTE HÄHL, SAMMONTIE 15
LHH HELSINKI: HELSINGIN DIESEL OY, HARKKORAUDANTIE 1
LHK HELSINKI: KAMPIN HUOLTAMO KY, LEPPASUONKATU
LHN HELSINKI: AUTO-SÄHKÖ NYKANEN OY, KYTKINTIE 43
LHU HUMPPILA: HUMPPILAN AUTOSÄHKÖ
LHY HYVINKÄÄ: HYVINKÄÄN AUTOSÄHKÖ OY, RAUHAMAKI

I

LII IISALMI: DIESEL-TALO KY, YRITTAJANTIE 2
LIM IMATRA: IMATRAN AUTO-SÄHKÖ KY, VALVATINKATU 1

J

LJA JUVA: JUVAN AUTOHUOLTO
LJK JYVÄSKYLÄ: KESKI-SUOMEN AUTOSÄHKÖ KY, PALOKANKAANTIE 11
LJO JOENSUU: JOEN DIESEL

K

LKÖ JOENSUU: AUTO-ELEKTRONIikka KÖNÖNEN, ASPITIE 15
LKA KAJAANI: KAJAANIN SÄHKÖDIESEL OY, KETTUKALLIONTI 15
LKB KEURUU: AUTOKORJAAMO IIKKA SIMULA,
LKC KOKKOLA: KOKKOLAN AUTOHUOLTO, LAAJALAHMENTIE 6
LKD KOUVOLA: KOUVOLAN DIESELKORJAUS KY, KAITILANKATU 15

6. FINNLAND, FINLAND, FINLANDE, FINLANDIA, FINLANDIA,



K

LKE KERAVA: KESKI-UUDENMAAN DIESEL OY, PELTOMAENKATU 8
 LKF KAUAJOKI: VM-KONE, KENTTATIE 2
 LKG KITEE: KITEEN KONE-DIESEL KY, PELTORIE 1
 LKH KURIKKA: KY DIESELHUOLTO M. HAHTOLA
 LKI KITTILÄ: KESOIL M. JUNTARI VALTATIE
 LKK KOUVOLA: KOUVOLAN AUTOSÄHKÖ OY, TAKOJANTIE 4
 LKL KLAUKKALA: KLAUKKALAN DIESEL KY
 LKM KOSKENKORVA: AUTO-SÄHKÖ M. MATALAMAKI
 LKN KANKAANPÄÄ: POHJOIS-SATAKUNNAN AUTO-JA KONEHUOLTO, ASEMAKATU 2
 LKO KOKKOLA: OY HARTMAN-AUTO AB, NIITTYKATU 2-4
 LKP KEMINMÄÄ: AUTO-HUOLTO P. AHO, AUTOJILIJANTIE
 LKR KARHULA: REIJON DIESEL KY, RISTINKALLIONTIE
 LKS KUUSAMO: N. PESOSEN AUTOSÄHKÖKORJAAMO, ERAKKOTAIVAL 2
 LKT KUUMO: TIIRAN AUTOSÄHKÖ, VALIMONTIE 6
 LKU KUOPIO: SAVON DIESEL OY, KAIVOTIE 38
 LKV KUORTANE: AUTOSÄHKÖ HARRI VESTERI
 LKW KARHULA: AUTO-WATTI, RISTINKALLIONTIE
 LKX KOKKOLA: DIESEL-HUOLTO HAAPASALO, VASARAKUJA 1B

L

LLA LAHTI: KONEHUOLTO MAKINEN KY, AUKEANKATU
 LLD LOIMAA: LOIMAAN DIESEL, TEOLLISUUSKATU 8
 LLL KOLARI: SHELL P. SYVAJARVI KY
 LLM LAPPEENRANTA: MOKES KY, RATAKATU 31
 LLP LAPUA: LAPUAN DIESELHUOLTO
 LLS LOHJA: AUTO-RELE H. VALIMAKI, LEVYSEPPÄNTIE 5

M

LMA MAARIANHAMINA: KALMERS AB, INDUSTRIHUSET
 LMI MIKKELI: MIKKELIN AUTOTARVIKE FORRASSALMENKATU 33, WERKSTATT: KAAPELIKATU 5
 LML MIKKELI: LAILAVUON DIESEL OY, JUONTOTIE 5
 LMY MYNÄMÄKI: MYNÄ-DIESEL, NIHATTULA

N

LND TEUVA: ETELA-POHJANMAAN DIESEL, OMNINKUJA
 LNK NIVALA: ASENNUSPALVELU HEIKKI KAARLELA, TEOLLISUUSKYLA
 LNU NUMMELA: NUMMELAN AUTOSÄHKÖ, AJURINTIE 6

O

LOD OULU: OULUN DIESEL-TURUNEN KY, ALASINTIE 11 B
 LOS OULU: AUTOSÄHKÖKORJAAMO KYLMANEN KY, TYRNAVANTIE 12

6. FINNLAND, FINLAND, FINLANDE, FINLANDIA, FINLANDIA,



P

LPD PORVOO: PORVOON DIESEL, YRITTÄJÄNKATU 1
 LPU PORI: PORIN SÄHKÖDIESEL OY, PUINNINTIE 23

R

LRA RANUA: TB H. SAKKINEN KY
 LRH RAAHE: RAAHEN DIESEL, HUOLTOKATU 2
 LRI RIIHIMÄKI: RIIHIMÄEN AUTOTALO OY, PALOHEIMONKATU 24
 LRM RAUMA: RAUMAN AUTOSÄHKÖ JA DIESELHUOLTO, KAIRAKATU 7
 LRO ROVANIEMI: DIESELROI KALLINEN KY, LUKKATIE 3
 LRS ROVANIEMI: AUTOSÄHKÖ-AKKUPALVELU KY, KEMINTIE

S

LSB SUNDOM: SUNDOM BIL-EL KB
 LSC SALO: SEPPÖ KUUSMA OY, JOENSUUNKATU 9
 LSH SYKÄRÄINEN: AUTOSÄHKÖ JUHANI HONKALA
 LSK SODANKYLÄ: SODANKYLÄN AUTOSÄHKÖ, TÄRKKÄLÄNTIE 24
 LSP SAVONLINNA: DIESEL-PERTTI, PAJATIE 9
 LSS SALO: SALON AUTOSÄHKÖ, ÖRNINKATU 8

T

LTA TURKU: TURUN AUTOSÄHKÖ OY, RIESKALAHTENTIE 72
 LTD TURKU: TURUN DIESEL KY, HÄMEENTIE 35
 LTE TIUKKA: ELEKTROAUTO KY KB
 LTL TAMPERE: LEMPISÄN AUTOSÄHKÖ, KESKUUJANKATU 7
 LTF TAMPERE: DIESELPOJAT, KESKUUJANKATU 7
 LTR TAMPERE: KURJENMAAN KORJAAMOT, KORJAAMONKATU 1
 LTS TAMMISAARI: DIESEL-KORPELA

U

LUK UUSIKAUPUNKI: KANERVAN AUTOLIIKE KY, KUMPUTIE 1

V

LVA VAASA: HIOMO K. ISOKANGAS. SILMUKKATIE 7
 LVI VIHANTI: VIHANNIN AUTO-JA KONEKORJAAMO
 LVK VARKAUS: AUTOSÄHKÖ-DIESELHUOLTO PATRONEN KY, RELANDERINKATU 80
 LVM VAMMALA: VAMMALAN AUTOSÄHKÖ, ASEMAKATU 26
 LVU VIITASAARI: UNSKAN AUTOHUOLTO KY

6. FINNLAND, FINLAND, FINLANDE, FINLANDIA, FINLANDIA,



Y

LYS YLIHARMA: AUTOSAHKÖ KEIJO SAARIMAA

6. NORWEGEN, NORWAY, NORVEGE, NORUEGA, NORVEGIA,

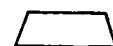

A

NAA 1414 TROLLASEN: OPPEGARD ELEKTRO-DIESEL AIS, TROLLASVN. 8
NAB 5050 NESTTUN: FANA BILVERKSTED A/S, FANAVERN. 15
NAC 2400 ELVERUM: GROTTING ELEKTRO-DIESEL A/S, SVARTBEKKVEIEN
NAE 2600 LILLEHAMMER: FYKSEN ELEKTRO-DIESEL A/S, INDUSTRIGT.37 B
NAF 6400 MOLDE: LONSETHAGEN ELEKTRO-DIESEL A/S, MOLDEGARDSVEIEN 5
NAH 1700 SARPSBORG: OSTFOLD ELEKTRO-DIESEL A/S, GLOMVERN.6, TUNEJORDET
NAI 3200 SANDEFJORD: FOKSEROD ELEKTRONIKK A/S
NAJ 4000 STAVANGER: ASENTERET, SANDGREN & CO. A/S, AUGLENDSMURA 11
NAK 9000 TROMSO: NOR-DIESEL EL.SERVICE A/S, STAKKEVOLVEIEN 69
NAM 3100 TONSBERG: VESTFOLD ELEKTRO-DIESEL A/S, KILENGATE 20

B

NBA 4800 ARENDAL: BATTERI-ELEKTRO - ROLF ROSE, KYSTVN.48
NBE 4350 NAERBO: REIME & LODE BILELEKTRO A/S
NBF 2870 DOKKA: BIL-ELEKTRISKE W. SOMDEN, VESTTORPVERN.12
NBG 3000 DRAMMEN: HANS D. NEVES EFTF., HOLMESTRADVEIEN 98
NBH 7320 FANNREM: EINAR NOSEN & CO.
NBI 2270 FLISA: BILELEKTRISKE V/HARRY BRENDE, ANNA SPARBYS V.
NBK 1600 FREDRIKSTAD: A/S ELEKTRO, HOLMEGT.1
NBL 6800 FORDE: DIESEL & ELEKTROSERVICE A/S, HALBRENDSTIA
NBM 2300 HAMAR: HOELS ELEKTROSERVICE A/S, ST.OLAVSGT.96
NBN 2645 HARPEFOSS: BAKKE BIL ELEKTRO
NBO 9400 HARSTAD: HARSTAD DIESEL-ELEKTRO A/S, KLUBBVN.2
NBP 5500 HAUGESUND: A/S DIESEL, SKJOLDAVEIEN 121 SOLVANG
NBT 7580 SELBU: MOSLET VERKSTED, MOSLETTA
NBU 3500 HONEFOSS: RING DIESEL-ELEKTRO A/S, DRONNING ASTASGT.20
NBX 2200 KONGSVINGER: SNARE ELEKTRO-DIESEL A/S, KONGSVN.20
NBY 6500 KRISTIANSUND N: A/S AUTO-ELEKTRO, W. DALLSVEI 25
NBZ 3270 NANSET: FINN'S BILELEKTRO, GJAERDAL

C

NCA 7600 LEVANGER: LEVANGER ELEKTRO-SERVICE, NESSET
NCB 1900 FETSUND: AUTO ELEKTRO A/S, NERDRUMSVEIEN, AKRENE
NCC 2007 KJELLER: SVEN AAS ELEKTRO-DIESEL A/S, FETVEIEN 171
NCD 1342 JAR: LYSAKER AUTO-ELEKTRISK A/S, VOLLSVN. 74
NCE 4500 MANDAL: DEKKMANN A/S MANDAL AUTOELEKTRO, SOMMERKROVEIEN
NCF 3050 MJONDALEN: ELEKTRO-DIESEL K. KRISTOFFERSEN & CO.
NCG 8600 MO I RANA: MO VIKLEVERSKSTED, REDVALD KNUTSONSVEG 3
NCH 1500 MOSS: HOIDEN ELEKTRISK, RYGGEVN.70
NCM 0917 OSLO 9: OSLO BILELEKTRISKE A/S, STANSEVN.27
NCN 5265 YTRE ARNA: STAMMESHAGEN AUTO A/S, PETER JEBSENSVEI 73
NCO 3200 SANDEFJORD: ALF HANSENS VIKLE- OG EL.REP.VERKSTED, FRAMNESVEIEN 1
NCP 4300 SANDNES: SANDNES ELEKTRO-DIESEL A/S, GJESDALSVEIEN 7
NCR 4300 SANDNES: VARHAUGS DIESEL-ELEKTRO A/S, LURA
NCS 9370 SILSAND: BERGLUNDS BILELEKTRO
NCU 1820 SPYDEBERG: KNAPAS ELEKTRISKE A/S, STASJONSVN. 4
NCW 4000 STAVANGER: STAVANGER BILELEKTRO, SORFLATVN.9
NCX 7700 STEINKJER: STEINKJER ELEKTRO-DIESEL A/S, FIGGA
NCY 6600 SUNNDALSORA: MELKILDS BILVERKSTED A/S, NORDMORSVEIEN 35

6. NORWEGEN, NORWAY, NORVEGE, NORUEGA, NORVEGIA,



D

NDB 2500 TYNSET: MOTORDEPOTET A/S, RINGVN 4 D
NDC 6065 ULSTEINVIK: SERVICE A/S MOBILSTASJONEN
NDD 7650 VERDAL: VERDAL ELEKTROSERVICE A/S, NORDGATA
NDE 4950 RISOR: BDR. ELLEFSEN EFTF. A/S, KRANVEIEN 58
NDG 6652 SURNA: SVEEN MEK. OG ELEKTRO A/S
NDH 1351 RUD: STABELL AUTO, RUDSLETTA 78
NDI 5783 EIDFJORD: HSD SERVICEVERKSTED
NDJ 8650 MOSJOEN: NYLAND ELEKTRO DIESEL A/S, OYFJELLGT. 3 OYA
NDK 4600 KRISTIANSAND: SENTRUM DIESEL, TANGEN 9A
NDL 7800 NAMSOS: FJELLETS ELEKTRO A/S, SVERRSGT. 25
NDM 2422 NYBERGSUND: NYBERGSUND BENSIN & SERVICE
NDN 7341 OFFDAL: REINKINDS AUTOSERVICE, KASENVN. 3
NDO 2830 RAUFOSS: ARNE WANGEN A/S
NDP 8000 BODO: BILELEKTRO A/S, TOMRERVN. 5
NDR 7000 TRONDHEIM: KLEVE-DIESEL A/S, LADEVEIEN 18
NDS 6100 VOLDA: HALKJELSVIK BILVERKSTED, INDUSTRIGT. 19
NDT 4270 AKREHAMN: AUTOSERVICE A/S, RADHUSGT.
NDU 6001 ALESUND: MOEN ELEKTRO-DIESEL A/S, KIFFERVIKGT. 27
NDV 5080 EIDSVAG: EIDSVAG AUTO A/S, EIDSVAGBAKKEN 21
NDW 2660 DOMBAS: DOMBAS AUTO SENTER

6. ÖSTERREICH, AUSTRIA, AUTRICHE, AUSTRIA, AUSTRIA,

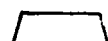

A

OAM AMSTETTEN: FIRMA RIEDL

D

ODR DORNBIRN: FIRMA RIEKER

G

OGE GÜSSING: FIRMA SCHATZ, DRASKOVICH GES. M. B. H
OGH GMUNDEN: FIRMA HAUSHERR
OGR GRAZ: FIRMA KOCH

H

OHS HARTBERG: FIRMA PROKOP

I

OIN INNSBRUCK: FIRMA FALLNHAUSER

K

OKL KLAGENFURT: FIRMA KOCH
OKR KREMS: RAIFFEISEN LAGERHAUS REG. GENOSSENSCHAFT MIT BESCHRÄNKTER HAFTUNG

L

OLA LANDECK: FIRMA SCHIMPFÖSSL
OLE LEOBEN: FIRMA BANDL
OLI LINZ: FIRMA WESTEN

M

OMU MURAU: FIRMA GLADIK

N

ONW WIENER NEUDORF: FIRMA WOELFL

6. ÖSTERREICH, AUSTRIA, AUTRICHE, AUSTRIA, AUSTRIA,

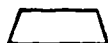

R

ORE RIED: FIRMA KAINZ

S

OSI STRASS: FIRMA FALCH
OSM ST. PÖLTEN: FIRMA MARCHHART
OSR STEYR: FIRMA KOGLER
OSS SALZBURG: FIRMA SCHWEIGHOFER
OSX SPITTAL: FIRMA PURAT
OSY STEYR: FIRMA KUBIK

V

DVW VILLACH: FIRMA WALDNER

W

OWG WIEN 22: FIRMA GOMBAS
OWH WIEN 14: FIRMA AMS-NUSSBAUMER
OWI WIEN 11: FIRMA AUTO-MAGNETO-SERVICE
OWK WELS: FIRMA PETER KLENNER KG
OWL WELS: FIRMA WESTEN
OWN WR.NEUSTADT: FIRMA SCHELNAST
OWO WÖRGL: FIRMA WEGSCHEIDER
OWF WOLFSBERG: FIRMA KNES, PAUSCHA & SCHREIER
OWR WIEN 19: FIRMA REINFRECHT
OWS SCHWECHAT: FIRMA KADLETZ
OWW WIEN 17: FIRMA GRÖGOR
OWZ WIEN 12: FIRMA GIGL

6. POLEN, POLAND, POLOGNE, POLONIA, POLONIA,

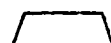

T

FTM WARSCHAU: TRANSMAJA

6. SCHWEDEN, SWEDEN, SUEDE, SUECIA, SVEZIA,



A

SAA BANDHAGEN: EL & DIESEL I STOCKHOLM AB
 SAB BODEN: ELEKTRO-DIESEL AB
 SAC BORLÄNGE: KROONS BILEL & DIESEL I BORLÄNGE AB
 SAD BORÅS: DAHLIN & BERG BILELEKTRISKA AB
 SAE ESKILSTUNA: EL & DIESEL I SÖDERMANLAND AB
 SAG FALKENBERG: AB FALKENBERGS BILELEKTRISKA
 SAH FALUN: KROONS ELEKTRO-DIESEL
 SAI GÄVLE: KROONS BILEL & DIESEL I GÄVLE AB
 SAJ GÖTEBORG: AKITA EL & DIESEL AB
 SAK HALMSTAD: EL- & DIESEL TJÄNST I HALMSTAD AB
 SAL HELSINGBORG: ELEKTRO-DIESEL I HELSINGBORG AB
 SAM HISINGS BACKA: STRÖMKVIST & CO BILELEKTRISKA AB
 SAO JÖNKÖPING: SJÖLINS ELEKTRODIESEL I JÖNKÖPING AB
 SAR KARLSTAD: BRANZELLS ELEKTRO-DIESEL AB
 SAS KATRINEHOLM: K. E. ANDERSSONS ELEKTRISKA AB
 SAT KIRUNA: ELEKTRO-DIESEL AB
 SAV KRISTIANSTAD: ELEKTRO-DIESEL I KRISTIANSTAD AB
 SAY LIDKÖPING: GUSTAFSSONS BIL-EL & DIESEL
 SAZ LINKÖPING: EL & DIESEL I ÖSTERGÖTLAND AB

B

SBB LULEÅ: WIBERGS BILEL & DIESEL AB
 SBC MALMÖ: ELEKTRO-DIESEL I MALMÖ AB
 SBD MORA: MORA AUTO-ELEKTRISKA AB
 SBF NORRKÖPING: EL & DIESEL I ÖSTERGÖTLAND AB
 SBG NORRTÄLJE: NORRTÄLJE BIL-ELEKTRO AB
 SBI PITEÅ: AB SANDBORGS DIESEL & BILELEKTRISKA
 SBJ SALÅ: EL- OCH DIESEL I SALÅ AB
 SBK SKELLEFTEÅ: AB SKELLEFTEÅ EL & DIESEL
 SBL SKÖVDE: LINDSTRÖMS BILELEKTRISKA EFTR AB
 SBN UDDEVALLA: DIESELSERVICE I UDDEVALLA AB
 SBO SUNDSVALL: AUTOSIB EL- & DIESELSERVICE AB
 SBP SÖDERTÄLJE: SÖDERTÄLJE EL- & DIESELSERVICE AB
 SBR TÖMELILLA: EL- OCH DIESELSERVICE
 SBS UDDEVALLA: EL & DIESEL I UDDEVALLA AB FÖRSÄLJNING
 SBU UPPSALA: KROONS BILEL & DIESEL I UPPSALA AB
 SBV VISBY: TURES BILELEKTRISKA HB
 SBX VÄSTERÅS: BRANZELLS ELEKTRO-DIESEL AB
 SBY VÄSTRA FRÖLUNDA: AB AUTOMAGNET
 SBZ VÄXJÖ: SJÖLINS ELEKTRO-DIESEL AB

C

SCA ÅKERSBERGA: ÅKERSBERGA BIL & MOTOR AB
 SCB ÖREBRO: BRANZELLS ELEKTRO-DIESEL AB
 SCC ÖSTERSUND: ELEKTRO-DIESEL I JÄMTLAND AB
 SCD NORRKÖPING: ROBERT BOSCH AB, CENTRALVERKSTADEN
 SCE LANDSKRONA: JONSSONS BILELEKTRISKA AB
 SCG STENUNGSUND: ELEKTRO CENTER I STENUNGSUND AB
 SCH STRÖMSTAD: STRÖMSTADS BILEL & BAT ELEKTRISKA HB

6. SCHWEDEN, SWEDEN, SUEDE, SUECIA, SVEZIA,

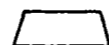

C

SCJ VETLANDA: WERNERSSONS BILELEKTRISKA
 SCK ARVIKA: ARVIKA BILEL AB
 SCL ALINGSÅS: ALINGSÅS BILELEKTRISKA AB
 SCM ARVIDSJAUR: A. SUNDQUIST BILVERKSTAD AB
 SCN FALKÖPING: FALKÖPINGS EL & BILSERVICE
 SCO FINSPANG: KOLARIC BILELEKTRISKA AB
 SCR KARLSKRONA: BATTERICENTRALEN I KARLSKRONA AB
 SCS KLIPPAN: ABY BILELEKTRISKA AB
 SCT LJUNGBY: LJUNGBY ELEKTROMEKANISKA AB
 SCU MÖNSTERÅS: BILELEKTRA KJELL PETERSSON
 SCV NORDMALING: A. BACKSTRÖM & CO. AB
 SCX OLOFSTRÖM: GUMMESSONS BILELEKTRISKA
 SCY OSKARSHAMN: OSKARSHAMNS BILELEKTRISKA
 SCZ FAJALA: FAJALA BILELEKTRISKA

D

SDA PARTILLE: GENOSTART
 SDB RONNEBY: RONNEBY DIESEL & ELTEKNIK KB
 SDC SIMRISHAMN: BILELEKTRO I SIMRISHAMN HB
 SDD SKARA: SKARA BILELEKTRISKA
 SDE SKOG: BOSTRÖMS ELEKTROMEKANISKA
 SDF SOLLEFTEÅ: SOLLEFTEÅ BIL-EL AB
 SDG STOCKHOLM: AB TRAKTOR- & DIESELSERVICE
 SDH TIBRO: TIBRO BILEL & DIESEL AB
 SDI TÄBY: SERVICEPUNKTEN I TÄBY AB
 SDJ UMEÅ: UMEÅ BILEL & DIESEL
 SDK ÅRNÄSVALL: ÖVIKS AUTO-EL
 SDL DOROTEÅ: DOROTEÅ BILSERVICE
 SDM GALLIVARE: HEINOS BIL-EL AB
 SDN HALLSTAHAMMAR: AUTOELEKTRISKA
 SDO KALIX: STRÖMBECKS BIL & MARIN
 SDP LINDESBERG: BRUNDIN-BR ERIKSSON BILSERVICE AB
 SDR LUDVIKA: EL O HYDRAULTEKNIK AB
 SDS MOTÅLA: MOTÅLA AUTOEL AB
 SDT SVENLJUNGA: LUNDHS BILSERVICE
 SDU BREDBYN: BIL & MOTOR HB
 SDV HUDIKSVALL: DAHLQVISTS BILSERVICE
 SDX KALMAR: AB KALMAR ELEKTRO-DIESEL
 SDY KARLSHAMN: STERNÖ BIL AB
 SDZ KRYLBO: KRYLBO ELEKTRA AB

E

SEA KUNGÄLV: KALLES BILEL AB
 SEB MÄRSTA: MÄRSTA EL O DIESELSERVICE AB
 SED SOLNÅ: FALKMANS DIESELSERVICE AB
 SEE STORUMÅN: STORUMÅNS BIL & EL AB
 SEF SÖDERHAMN: GK. S FORDONSEL AB
 SEG ÄNGELHOLM: BJÄRE SLÄP OCH BILELEKTRO AB
 SEH ÅRBOGA: TL. S BIL O MOTOR AB

6. SCHWEDEN, SWEDEN, SUEDE, SUECIA, SVEZIA,



E

SEI ARJEPLOG: ARJEPLOGS MASKIN & SKOTER
SEJ HANINGE: HTM-MASKINSERVICE HB
SEK HOFORS: EL & FORDONSSERVICE AB
SEL LAHOLM: KÖVLINGE BILELEKTRISKA
SEM LUND: MOTORKONSULT
SEN MARKARYD: MARKARYDS EL & DIESEL AB
SEO MUNKFORS: MUNKFORS BILELEKTRISKA
SEP RÄTTVIK: RÄTTVIKS BILSERVICE AB
SER VINDELN: BIL O TRAKTOR I VINDELN AB
SES ÄLVSBY: ELEKTROLINDNING I ÄLVSBY AB
SET JOKKMOKK: JOKKMOKKS BIL & BLAT
SEU FRILLESAS: LÖFTA BIL HB
SEV NYKÖPING: NYKÖPINGS EL & DIESELSERVICE

6. TÜRKİ, TURKEY, TURQUIE, TURQUIA, TURCHIA,



A

TAA İSTANBUL: ROBERT BOSCH MOTORLU ARAÇLAR YAN SAN.
TAB ADANA: AKDENİZ POMPA - ABDULLAH KALYENCI
TAC ADANA: POMPA-YILDIZLAR-MUZAFFER YILDIZ
TAD ADANA: BOSCH DİZEL POMPA SER.-M.SENOL AYKIN-ALİ YENTİMÜR
TAE ADAPAZARI: AS POMPA-BURHAN-FLHAN-ALİ SALKIM
TAF ADAPAZARI: BOSCH SERVİS İSTASYONU - EYÜP ÇELİKEL
TAH ANKARA: SAİT VAGAS - ATA SANAYİ
TAI ANKARA: URAZ MOTORLU ARAÇLAR TIC.VE SAN.A.S. NECMETTİN URAZ
TAK ANKARA: YILLAR TİCARET - ENVER YILMAZ
TAL ANTALYA: SELÇUKLAR KOLL.STİ.-İSMAIL HAKKI SELÇUK
TAM BABAESKİ KIRKLARELİ: OCALLAR DİZEL CEMİL ÖCALLAR
TAN BAFRA SAMSUN: KEMALOĞLU TIC.KOLL.STİ.-KEMAL KEMALOĞLU
TAD BALIKESİR: KÖYDES OTOMOTİV TIC.VE SAN.A.S.
TAP BANDIRMA BALIKESİR: İLYAS DİZEL POMPA AYARI - GÜNAY AVCIOĞLU
TAR BARTIN ZONGULDAK: ABANALILAR OTO ELEKTRİK SERVİSİ - TANER ABANALİ
TAS BOLU: ERGİN DİZEL - FAHRETTİN ERGİN
TAU CEYHAN ADANA: İSİK TEKNİK DİZEL - MUSTAFA İSİK
TAV ÇORLU TEKİRDAĞ: TEKNİK DİZEL - BARBAROS ÇAKIN
TAW DİYARBAKIR: AHMET NEDİMOĞLU
TAX ERZİNCAN: GARANTİ POMPA - ZEKİ BAYRAKLI
TAY ERZURUM: AĞIRBAS POMPA AYAR ATÖLYESİ - SŞEFİK AĞIRBAS
TAZ ERZURUM: TUNA ATELYEST-FAHRETTİN ATINÇ

B

TBA ESKİŞEHİR: KÖYDES TAMİR TIC. VE SAN. LTD. STİ. ENNAN MANGUTLU
TBB ESKİŞEHİR: OTO SÜRAT - NURETTİN ASLAN
TBC GAZİANTEP: ÜSTALAN POMPA AYAR SERVİSİ - HAYRİ ÜSTALAN
TBD İSTANBUL: BOSCH SERVİS - SEZAY YÜCE
TBE İSTANBUL: BİROL DİZEL SAN. VE TIC. - TURAN BİROL
TBG İSTANBUL: DİZEL POMP OSMAN GÜVEN
TBH İSTANBUL: EMKAR TİCARET - MAHİR
TBI İSTANBUL: OTO MAZOT - NECATİ YAVUZ
TBK İSTANBUL: OTO POMP TANER ÖZGÜÇ
TBM İZMİR: ERCAN POMPA - ERCAN HÜNERLİ
TBN İZMİR: LEVENT OTO - CİHAAT AYDIN
TBP İZMİR: POMPA ENJEKTÖR AYAR SERVİSİ-YILMAZ KOÇ
TBR KARABÜK ZONGULDAK: TEKNİK EL POMPA-TAHSİN ÖLCER-ZEKERİYA ÖZÇELİK
TBS KARACABEY BURSA: ÖZEL DONATIM DERVİS ÖZDEMİR
TBT KARS: URALLAR TİCARET NURETTİN URAL
TBU KAYSERİ: ATA TİCARET AHMET TURAN AKGÜN
TBV KESAN EDİRNE: YILMAZ POMPA-FARUK YILMAZ
TBW KONYA: TEKNİK POMPA MEHMET VE MUHİTTİN KÜÇÜKSÜCÜ
TBX KONYA: KOR OTO ELEKTRİK - NEZİH KÜÇÜK
TBY KONYA: SÜPER DİZEL TIC.VE SAN. KOLL.STİ.-LATİF-LÜTFÜ DELİBASİ
TBZ LÜLEBURGAZ KIRKLARELİ: KAYNAK DİZEL - HASAN VE FERİT KAYNAK

6. TÜRKİE, TURKEY, TURQUIE, TURQUIA, TURCHIA,



C

TCA MALATYA: DOGU DIZEL - NEJDET ÖZYALIN
 TCB MANAVGAT ANTALYA: ERTUGRUL SELCUK
 TCC SAMSUN: OTO CAMLIBEL - EROL CAMLIBEL
 TCD SAMSUN: SÜPER ELEKTRO DIZEL - REFIK KAHVECIOGLU
 TCE SÖKE AYDIN: ÖZGÜR İS - ÖZER ANYA
 TCF SIVAS: GÜNEŞ POMPA AYAR SERVİSİ - AHMET GÜNEŞ
 TCG TOKAT: OTO YARBAC - NURETTİN İBAC
 TCH TRABZON: FENİS DIZEL - MEHMET CALAF
 TCI SANLIURFA: NAS DIZEL - NABİ SINDIRAC
 TCK UZUNKÖPRÜ EDİRNE: ERGÜN BILGIN BILGINLER MOTOR SAN.VE TIC.A.S.
 TCL İSKENDERUN: UĞUR KARDEŞLER - SAKİR UĞUR
 TCM KIRIKHAN HATAY: UĞUR KARDEŞLER-EROL UĞUR
 TCN MERSİN: UMUT DIZEL - OKTAY SAHINGÖKLÜ
 TCO YERKÖY YOZGAT: SÜPER DIZEL POMPA - GÜNGÖR DOĞAN
 TCP CORUM: UĞURAL DIZEL - ERTURAN-UĞUR ATLAMAZ
 TCR KR.D.EREGLİSİ: AKDİZEL KOLL.STİ.-KAMİL VE İSMAİL AKCIRAY
 TCT AFYONKARAHİSAR: KARCI OĞLU POMPA-MAHMUT KARCI
 TCU MERSİN: GÜNEY POMPA ENJ. VE AYAR SERVİSİ-YÜKSEL EMÜL
 TCV GAZİANTEP: GÜNEYDOĞU POMPA AYAR SERVİSİ - EKREM KATAN
 TCW SÖKE-AYDIN: CAN KARDEŞLER-HÜSEYİN CAN
 TCY DÜZCE BOLU: SOYLU DIZEL - ÖMER SOYER
 TCZ KAHRAMANMARAS: DIZEL AKSAM - AHMET KİLİNCKİRAN

D

TDA CATALCA İSTANBUL: GÜRLER OTO ELEKTRİK SERVİSİ - GÜRSEL DEMİRALP
 TDC KONYA: BAĞRIACIKLAR OTO ELEKTRİK AHMET K. BAĞRIACIK
 TDD İZMİR: BOSCH MOTOR TEST VE BAKIM SERVİSİ - TURGAY AKBAS
 TDE CORUM: FENİS OTO ELEKTRİK VE DİNAMO ATÖLYESİ-METİN GAZEL
 TDF KAYSERİ: ESER POMPA EMİN ESER
 TDG GAZİANTEP: FEN İS POMPA AYAR SERVİSİ - ALİ BALKAN
 TDH MERSİN: AKDENİZ MOTOR RÖNTGEN - MUSTAFA GÜRTEKİN
 TDM BURSA: COŞKUN POMPA-COŞKUN ÖZEZGİ
 TDN İZMİR: DIZEL TEST POMPA ENJ.SERVİSİ-RAMAZAN TERZİ
 TDO AKSARAY/NİĞDE: ATILGAN OTO ELEKTRİK-ALİ ATILGAN
 TDP İSPARTA: GÜVEN POMPA TİCARET-YASAR YAVUZ
 TDR OSMANİYE/ADANA: CESUR POMPA-CESUR KEKLIKCIOGLU
 TDS SİNOP: ADAL ELEKTRO TEKNİK-ADEM TAHTACI
 TDU DİYARBAKIR: ÖZ DIZEL - A.MECİT ÖZUGUR
 TDV BIGA/CANAKKALE: ÖZCELİK POMPA - MEHMET ÖZCELİK
 TDW DENİZLİ: ÖZCELİK POMPA - MUFİT - ERHAN ÖZCELİK
 TDX DÜZCE/BOLU: BALABANLAR KOLL.STİ. - SEREF BALABAN VE ORT.
 TDY BUCAK/BURDUR: DEMİREZEN POMPA - HASAN DEMİREZEN
 TDZ AFYONKARAHİSAR: SALİM OTO ELEKTRİK - SALİM KASNAK

6. TÜRKİE, TURKEY, TURQUIE, TURQUIA, TURCHIA,

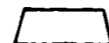

E

TEA İSTANBUL: DIZEL POMPA ADI KOM.STİ.-RÜSTEM KUDEKİ VE ORT.
 TEB İSTANBUL: AYBAK JETRONIC - KADRI İLHAMİ KASAP
 TEC KONYA: OTO SAFAK - ALİ BOSTANCI
 TED ANKARA: OKYAY MAKİNA TAMİR TİC.SAN.LTD.STİ.-YAVUZ OKYAY
 TEE ANKARA: TERMAN TİCARET - RESUL ÜNAL
 TEF ANTAKYA/HATAY: EMEK POMPA VE ENJ.AYAR ATÖLYESİ - M.ALI TASCIOĞLU
 TEG ANTALYA: İSLEK OTO ELEKTRİK - OSMAN İSLEK
 TEH ANTALYA: DOĞAN MAKİNA TİCARET - DOĞAN DEMİRTAS
 TEİ AYDIN: ÖZDİZEL POMPA ENJ.AYAR ATÖLYESİ-MUSTAFA KATIRCIOĞLU
 TEK BURDUR: KONYALILAR DIZEL POMPA - ADEM SEN
 TEL CANAKKALE: ENDER POMPA - SELİM KARPUZ
 TEM DİNAR/AFYON: DİZELMAK MAZOT POMPA SERVİSİ - MEHMET TANRIVERDİ
 TEN EDİRNE: KARDEŞLER POMPA - TEVFIK - SALİM ERKOL
 TEO ERZURUM: OTO SEBAHATTİNLER - SEBAHATTİN - ALAHATTİN KÜLEKÇİ
 TEP GAZİANTEP: ÜMİT POMPA - HURŞİT KIRKGÖZ
 TER İSTANBUL: HİLAL POMPA - ÖZER KÜÇÜKGÜZEL
 TES SARUHANLI/MANİSA: CAĞLAR MAZOT POMPA ATÖLYESİ - SUAT TÜREL
 TET SALIHLI/MANİSA: YÜCEL POMPA - YILMAZ ACIKGÖZ - AHMET EFE
 TEU SAMSUN: GERCEK DIZEL - İSMET ZENGİN - SÜLEYMAN DALKILIC
 TEV TARSUS/MERSİN: GÜNEYLİLER POMPA - MEHMET CAN BUTLÜLER
 TEW TURGUTLU/MANİSA: TURCAN POMPA - ERDOĞAN TURCAN
 TEX ANKARA: ERDEM POMPA - HÜSEYİN KAVUNCU
 TEY BOLU: ÖZAK OTO ELEKTRİK - EROL ÖZAK
 TEZ BOLU: ÖZDEMİR POMPA - CEZMİ ÖZDEMİR

F

TFA FATSA/ORDU: DİZOMASTER DIZEL - O.NURİ DEMİRKOL - ORHAN DİNCER
 TFB HAVZA/SAMSUN: MUTLU DIZEL - SENOL - FEHİMİ MUTLU
 TFC İSTANBUL: MODERN OTO - SAİT YAZPINAR
 TFD MERSİN: GARANTİ DIZEL KEMAL SAHINGÖKLÜ
 TFE RİZE: SATIROĞLU POMPA - KADİR SATIR
 TFF RİZE: KARAAHMETOĞLU TİCARET - MUSTAFA KARAAHMETOĞLU

6. SPANIEN, SPAIN, ESPAGNE, ESPANA, SPAGNA,



A

UAA SAN BAUDILLO DE LLOBREGAT: SUR DIESEL
 UAB TARRASA: DIESEL PACO
 UAC VICH: AUTO DIESEL VICH, S.A.
 UAD VILAFRANCA DEL PANADES: SERVICIO DIESEL COLOMER
 UAE MANRESA: JUAN GIRALT
 UAF BARCELONA: AUTO TALLER YAWARA, S.A.
 UAG BARCELONA: TECNO DIESEL
 UAH MATARO: DIESEL MARESME
 UAI MOLINS DE REY: DIESEL INYECCION MOHEDANO
 UAJ SABADELL: SERVICIO DIESEL ARRIERO
 UAK SANTA COLOMA DE GRAMANET: GENERAL DIESEL
 UAL TARRASA: F. JORDI BOU MASIP
 UAM BURGOS: TLLS. DIESEL VICFERVAL
 UAN CACERES: DOMINGO BARROSO ARROYO
 UAO CACERES: S.A. MIRAT
 UAP ALGECIRAS: TALLERES DIESEL GALLARDO
 UAR CADIZ: GARAJE Y TALLER USTARIZ
 UAS CHICLANA DE LA FRONTERA: ANTONIO FORMELL MOLINA
 UAT PUERTO DE SANTA MARIA: TALLER AUTO ELECT. DIESEL
 UAU CADIZ: INDALBI SUR, S.L.
 UAV MALIANO: TALLERES DIESEL LANL
 UAW CAMPUZANO-TORRELAVEGA: TALLERES RUFER
 UAX CASTELLON: TALLERES VIVAS, S.L.
 UAY VALDEPENAS: JUAN DE DIOS MADRID N.
 UAZ VALDEPENAS: S. INYECCION LUMBRERAS

B

UBA CORDOBA: TALLERES BRICENO
 UBB PALMA DEL RIO: T. JOSE REJANO ROSA
 UBC FERROL, EL: ANTONIO VARELA PENA
 UBD SANTIAGO DE COMPOSTELA: TALLERES CASTY ROMER S.L.
 UBE SANTIAGO DE COMPOSTELA: TALLERES CASTY ROMER, S.L.
 UBF SAN SATURNINO NARAHIO: AUTOMOCION Y SERVICIOS
 UBG MOTILLA DEL FALANCAR: ANTONIO GONZALEZ MUNOZ
 UBH SARRIA DE TER: INYECCION Y SERVICIOS, S.A.
 UBI VILAMALLA: TALLERES ALVAREZ, S.A.
 UBJ BESALU: LEONARDO SANZ
 UBK VILATENIM: AUDISA, S.L.
 UBL GRANADA: SERVICIO TECNICO DIESEL
 UBM MOTRIL: TALLERES MARFESA
 UBN ALBOLOTE: TALLERES DIESEL MATIAS
 UBO GUADIX: INYECTO DIESEL
 UBP GUADALAJARA: AUTODASA
 UBR BEASAIN: GARAJE MODERNO
 UBS PASAJES DE SAN PEDRO: INDALBI, S.L.
 UBT IRUN: T. DIESEL ETXEGARAY
 UBU LEZO: TALLERES PUERTO
 UBV SAN SEBASTIAN: TALLERES SAYA
 UBW HUELVA: TALLERES CISMAR
 UBX PALOS DE LA FRONTERA: MI TALLER, S.A.
 UBY HUESCA: CANCER Y CEBRIAN

6. SPANIEN, SPAIN, ESPAGNE, ESPANA, SPAGNA,

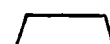

B

UBZ JACA: TALLERES RANJU, S.L.

C

UCA MONZON: AUTO REPARACION MONZON
 UCB JAEN: TALLERES BALLESTEROS
 UCC MARTOS: MANUEL CABALLERO CHICA
 UCD UBEDA: JABA, S.A.
 UCE NAVATEJERA: HERMANOS VUELTA VILLAFANE
 UCF GOLMES: DIESEL COMARCAL
 UCG LERIDA: TALLERES RUFRE
 UCH LERIDA: DIESEL LERIDA
 UCI LERIDA: TALLERES Y REC. PIFARRE
 UCJ SEO DE URGEL: GARAJE ROBERT
 UCK TREMP: GARAJE TOSQUELLA
 UCL BORDETA, LA: DIESEL FELIP
 UCM LUGO: GERMAN LOPEZ FOLGUEIRA
 UCN LUGO: ANSEDE DIESEL
 UCO MADRID: DIESEL AUTO
 UCP SAN SEBASTIAN DE LOS REYES: ANTONIO CABEZON PEREZ
 UCR MADRID: TALLERES CUENCA
 UCS MADRID: TALLERES JOCAR
 UCT MADRID: TALLERES MECANICOS J.A. GOMEZ
 UCU SAN PEDRO DE ALCANTARA: FRANCISCO SARRIA FRANCO
 UCV ALBUJON, EL: J. JOSE MARTINEZ TOMAS
 UCW CABEZO DE TORRES: CARLOS NICOLAS BAEZA
 UCX LORCA: TALLERES FEMAR, S.L.
 UCY SAN PEDRO DE PINATAR: ANTONIO ALBADALEJO PEREZ
 UCZ LOS DOLORES: PEPE DE LAS BOMBAS

D

UDA MURCIA: MANUEL GAMBIN FERNANDEZ
 UDB TUDELA: TALLERES DIESEL IGNACIO
 UDC ORENSE: JOSE LAMAS BLANCO
 UDD XINZO DE LIMIA: AUTO INYECCION JORGE
 UDE VIGO: GALICIA DE AUTOMOCION, S.A.
 UDF LOGRONO: SERVICIO DIESEL ALMAZAN
 UDG SALAMANCA: SALA DIESEL
 UDH SEVILLA: AUTO DISTRIBUCION, S.A.
 UDI SEVILLA: INDIESEL
 UDJ SEVILLA: TALLERES DIESEL BARCERA, S.L.
 UDK RODA DE ANDALUCIA, LA: TALLERES PAJUELO, S.L.
 UDL ECIIJA: RAFAEL GARCIA MARTIN
 UDM TARRAGONA: COOP. INDUSTRIAL AUTOMECANICA
 UDN TORTOSA: AUTO INYECCION
 UDO QUINTANAR DE LA ORDEN: TALLERES JOZMAR
 UDP QUINTANAR DE LA ORDEN: TURBO DIESEL GUERRERO
 UDR TALAVERA DE LA REINA: ANTONIO MANCERAS MORENO
 UDS TOLEDO: MARCELINO RODRIGUEZ
 UDT ALGEMESI: TALLERES FELIP



D

UDU GANDIA: SERVICIO TECNICO DIESEL
UDV OLIVA: FRANCISCO MARTINEZ FORNE
UDW VALENCIA: TALLERES NOGUERA
UDX CASAS DE BARCENAS: SERVICIO DIESEL CUFER
UDY GANDIA: SERVICIO DIESEL OLIVA
UDZ VALENCIA: JOSE MIGUEL NAVARRO

E

UEA VALENCIA: SERVICIO DIESEL IGLESIAS
UEB VALLADOLID: GARAJE CARRION
UEC VALLADOLID: AUTO INYECCION VICENTE
UED BILBAO: BRAVO MOTOR
UEE ZAMORA: TALLER CENTRAL DIESEL
UEF CALATAYUO: ALFREDO GIMENO



O

101 47000 AGEN: ETS.DUCOS
104 87021 LIMOGES CEDEX: SOCIETE TECHNIQUE DU CENTRE
108 81000 ALBI: ETS.COUBEIGNES-HAGEMANN

1

111 80000 AMIENS: ETS.VALOMER & CIE.
114 49001 ANGERS CEDEX 10: ETS.J.GUIHEUX S.A.
115 49000 ANGERS: ANGER ELECTRO DIESEL
116 16430 ANGOULEME CEDEX 72: ETS.LAPORTE
118 74370 PRINGY: ETS.ANDRE FOURCADE
119 13200 ARLES: DIESEL SERVICE SAUTECOEUR

2

120 62003 ARRAS CEDEX: S.N.J. PETIT
121 62217 ARRAS CEDEX: ETS.DELAHAY S.A.
126 71300 MONTCEAU LES MINES: ETS.GILLES CALLIER
127 32000 AUCH: ETS.CRISTOFOLI

3

132 89002 AUXERRE CEDEX: AUTO COMPTOIR DE L'YONNE
134 14022 CAEN CEDEX: ETS.MACHU
138 49400 BAGNEUX: SAUMUR ELECTRO DIESEL
139 94120 FONTENAY SOUS BOIS: ETS.H.AUMERLE

4

140 32720 BARCELONNE-DU-GERS: DIESEL HYDRO DE L'ADOUR
141 67140 BARR: AUTO ELECTRICITE
144 64100 BAYONNE: OMNIA ELECTRIC AUTO
147 60000 BEAUVAIS: BEAUVAIS DIESEL
149 01200 BELLEGARDE: ETS.B.GHILARDI

5

150 55100 VERDUN: VERDUN DIESEL
152 22300 LANNION: ETS.KERAUTO
153 27300 BERNAY: ETS.HAMON
157 34500 BEZIERS: BEZIERS EQUIPEMENT AUTO DIESEL

6. FRANKREICH, FRANCE, FRANCE, FRANCAIA, FRANCAIA,



6

160 76120 BOLBEC: ETS. B. COUSTHAM S. A.
161 33000 BORDEAUX: EQUIPEMENT AUTO DIESEL
162 33400 TALENCE: FOURNI AUTO, RUE DE ROUSTANG
163 33083 BORDEAUX CEDEX: ETS. NELSON
165 33000 BORDEAUX: ETS. FLANDRAUTO
166 33130 BEGLES: ETS. DELPEYROUX ET FILS
169 62200 BOULOGNE SUR MER: ETS. L. DUFLAY

7

173 18000 BOURGES: ETS. CLAUDE PIROT
177 29200 BREST: ETS. F. PILAYROU S. A.
179 19100 BRIVE LA GAILLARDE: ELECTRO DIESEL CORREZIEN

8

181 14202 HEROUVILLE SAINT CLAIR: ETS. J. LEROUX
187 06250 MOUGINS: CANNES ELECTRO DIESEL
189 11000 CARCASSONNE: ETS. BARUTEAU

9

190 11000 CARCASSONNE: CARCASSONNE DIESEL
191 11009 CARCASSONNE: ETS. PUEYO & CIE.
193 84200 CARPENTRAS: ETS. FERROUD & CIE.
194 74600 SEYNOD: ETS. CATEL
195 33700 MERIGNAC: ETS. LAFORTE
198 71106 CHALON SUR SAONE: ETS. P. GUILLEMARD
199 73000 CHAMBERY: ETS. GALLET CHALANSONNET

6. FRANKREICH, FRANCE, FRANCE, FRANCAIA, FRANCAIA,



0

203 08100 CHARLEVILLE-MEZIERES: ETS. DAVESNES & CIE.
204 72000 LE MANS: SIMAD
205 28110 LUCE CEDEX: ETS. MORIZE
209 28200 CHATEAUDUN: STATION ELECTRO DIESEL

1

211 36004 SAINT MAUR CEDEX: ETS. THERET
212 02400 CHATEAU-THIERRY: S. A. ROBY
214 50100 CHERBOURG: ETS. M. HUBERT
217 63100 CLERMONT FERRAND: ETS. J. SAURET

2

221 68000 COLMAR: ETS. DURR-FREY
222 68003 COLMAR CEDEX: ALSIA
225 78700 CONFLANS SAINTE HONORINE: DILOLOT S. A.
226 18000 BOURGES: ETS. FOUQUIAU
227 80136 RIVERY: C. L. C.
228 60103 CREIL CEDEX: ETS. ANDRIEUX & FILS

3

232 21000 DIJON: ETS. DIOTTE S. A.
236 21300 CHENOVE: DIJON ELECTRO DIESEL
237 22100 DINAN: ETS. JOUBIN
238 28103 DREUX CEDEX: ETS. PETIT-DOUPE
239 51200 EPERNAY: S. A. E. E. REAUDIN

4

240 88000 EPINAL: EPINAL ELECTRO DIESEL
241 35100 RENNES: ETS. FRERE
242 91150 ETAMPES: ETAMPES SERVICE DIESEL PIERRE LATTE
244 27002 EVREUX CEDEX: ETS. DEMOLIN EVREUX
245 27000 EVREUX: ETS. A. DESERT
246 27000 EVREUX: DYNAM' AUTO
247 61102 FLERS DE L'ORNE CEDEC: S. E. E. DECHARENTON & CIE.

5

251 69230 SAINT GENIS LAVAL: ETS. GIBELIN
253 23001 GUERET: ETS. MARCEL CAVERNES
255 78550 HOUDAN: ELECTRO DIESEL BOBINAGE DENIS
257 36100 ISSOUDUN: ETS. PIROT
258 94400 VITRY SUR SEINE: IVRY PORT DIESEL
259 92200 BAGNEUX: I. D. L. P., 258 AVENUE ARISTIDE BRIAND

6. FRANKREICH, FRANCE, FRANCE, FRANCA, FRANCA,

D

6

260 93120 LA COURNEUVE: NORD PARIS DIESEL
263 51055 REIMS CEDEX: S.A.E.ELECTRO DIESEL
264 33210 LANGON TOULENNE: STATION ELECTRO DIESEL
266 02000 LAON: STATION DIESEL J.BAUDOUX

7

270 17000 LA ROCHELLE: LA ROCHELLE DIESEL
271 8500 LA ROCHE SUR YON: S.E.E.ROLAND VACQUIER
272 53000 LAVAL: ETS.A.PATRIE
275 76600 LE HAVRE: ETS.R.LEBOURGEOIS
277 72002 LE MANS CEDEX: ETS.M.CHEVALLIER
278 72025 LE MANS CEDEX: LE HELLO S.A.

8

281 85105 LE MANS CEDEX: LE HELLO S.A.
281 85108 LES SABLES D'OLONNE: ETS.VACQUIER
287 59009 LILLE CEDEX: ETS.JACQUES PH.DANJOU

9

290 87000 LIMOGES: LIMOUSIN ELECTRO DIESEL
291 87000 LIMOGES: ELECTRIC AUTO JOUHAUD
292 91160 LONGJUMEAU: SERVICE DIESEL
294 39000 LONS LE SAUNIER: ETS.MANDRILLON FRERES
295 56107 LORIENT CEDEX: ETS.LENEVEU

6. FRANKREICH, FRANCE, FRANCE, FRANCA, FRANCA,

D

0

306 78204 MANTES CEDEX: CASTILLON S.A.
307 78206 MANTES LA JOLIE: MANTES ELECTRO DIESEL
308 59700 MARCQ EN BARDEUL: ETS.DESCAMPS & COUROUBLE

1

312 13127 VITROLLES: VITROLLES ELECTRO DIESEL
313 13014 MARSEILLE: SUD MARINE ENTREPRISE
315 77103 MEAUX: DIESELEC
316 77000 MELUN: MASSON ELECTRO DIESEL
318 57070 METZ: ETS.HUBERT INDUSTRIE
319 57006 METZ CEDEX: METZ DIESEL

2

321 82003 MONTAUBAN: S.E.A.R.D.I.
323 40002 MONT DE MARSAN: COMPTOIR INDUSTRIEL MONTIOS
324 40000 MONT DE MARSAN: ETS.SARTHOU
328 03101 PREMILHAT: ETS.CHANIER S.A.
329 39000 LONS LE SAUNIER: DIESEL TECHNIC

3

330 34006 MONTPELLIER CEDEX: AUTO MONTPELLIER INDUSTRIE
331 57200 SARREGUEMINES: ELECTRO DIESEL DE L'EST
332 29210 MORLAIX CEDEX: S.A.ELECTRO DIESEL
334 03008 AVERMES: S.A.MERCIER & CIE.
338 54710 LUDRES: EQUIPEMENT AUTO VACHER
339 54000 NANCY: NANCY ELECTRO DIESEL

4

341 68067 MULHOUSE: FIPAC SCHOETTLE
342 44000 NANTES: ETS.BUCAS & FILS
345 44880 SAUTRON: S.T.E.I.M.A
346 11100 NARBONNE: ETS.ALEXIS PIQUEMAL

5

350 06000 NICE: S.A.DES ETS.GOGGIO
351 06340 LA TRINITE: AZUR ELECTRO DIESEL
355 79006 NIORT CEDEX: ETS.A.DAVID
357 79000 NIORT: SOCIETE REDIEN & FILS
358 84100 ORANGE: BARTHELEMY S.A.

6. FRANKREICH, FRANCE, FRANCE, FRANCIA, FRANCIA,



6

360 45140 SAINT JEAN DE LA RUELE: ETS. PAUL LAPAUZE S.A.
364 75012 PARIS: BASTILLE ELECTRIC AUTO

7

372 64140 BILLERE: BLANCHARDET POIDS LOURD
373 24000 PERIQUEUX: ELECTRO DIESEL
374 24000 PERIQUEUX: AQUITAINE DIESEL
375 66004 PERPIGNAN CEDEX: ETS. FERRIER
377 73290 LA MOTTE SERVOLEX: ETS. GALBIT & CICERON
378 59640 DUNKERQUE: E. D. H. D.

8

382 27500 PONT AUDEMER: ETS. SUPPLICE
383 56304 PONTIVY CEDEX: ETS. P. HELSLY S.A.
385 26800 PORTE LES VALENCE: VALENCE DIESEL

9

390 51507 REIMS CEDEX: ETS. DESPREZ
392 35039 RENNES CEDEX: ETS. BESNARD ET GERARD
394 12850 RODEZ: ETS. KLEIN SNC
396 80170 ROSIERES EN SANTERRE: DIESEL FREINAGE SERVICE
397 76000 ROUEN: ETS. CAHAGNE FRERES S.A.

6. FRANKREICH, FRANCE, FRANCE, FRANCIA, FRANCIA,



0

400 76021 ROUEN CEDEX: ETS. NIORT FRERES
401 37200 ROYAN: ROYAN DIESEL
405 13654 SALON DE PROVENCE: ACCESSOIRES SALONNAIS
408 67600 SEJESTAT: ELECTRICITE AUTO STURNY
409 89100 SENS: AUTO COMPTOIR DE L'YVONNE

1

410 89100 SENS: ETS. JACQUES FOISSON
413 02202 SOISSONS: ELECTRO DIESEL SERVICE
414 67400 ILLKIRCH-GRAFFENSTADEN: ALSACE ELECTRO DIESEL
415 67009 STRASBOURG CEDEX: EQUIPEMENT ELECTRIQUE V. FREY
416 67000 STRASBOURG: ALFRED WOLLEK
418 22005 SAINT-BRIEUC CEDEX: A. D. L. A. I. D. SARL

2

422 52100 SAINT-DIZIER: R. N. 4. POIDS LOURDS
423 42000 SAINT-ETIENNE: EQUIP' AUTO ALLIROT
425 13000 MARSEILLE: D. E. GRILLON, 67-71 BLD. DE PLOMBIERES
426 78730 ORGEVAL: METTETAL SAINT GERMAIN ACCESSOIRES
427 31800 SAINT-GAUDENS: COMMINGES DIESEL
428 30560 SAINT-HILAIRE DE BRETHMAS: DIESEL SERVICE
429 50600 SAINT HILAIRE DU HARCQUET: SODIAMA

3

430 64500 SAINT JEAN DE LUZ: COMPTOIR INDUSTRIEL
432 50001 SAINT-LO: ETS. G. BORDERIEUX
433 38400 SAINT-MARTIN-D'HERES: ETS. SAVIN FRERES
437 59430 SAINT POL SUR MER: I. R. M.
439 02100 SAINT-QUENTIN: ETS. GERARD SERY

4

443 57100 THIONVILLE: S. E. E. MARCEL SCHNITZLER
446 83100 TOULON: ETS. J. CONSOLIN
447 83100 TOULON: ETS. PANSIER FILS & BRANTE
448 31021 TOULOUSE CEDEX: PARIS ELECTRO DIESEL S.A.

5

454 37170 CHAMBRAY LES TOURS: SLYDOS
457 10008 TROYES CEDEX: MORIN AUTO S.A.
458 10000 TROYES: ETS. TERRE

6. FRANKREICH, FRANCE, FRANCE, FRANZIA, FRANZIA,

D

6

462 56005 VANNES CEDEX: QUEST ELECTRO INJECTION
464 78190 TRAPPES: SAINT-CYR ACCESSOIRES AUTO
465 70001 VESOUL CEDEX: VESOUL ELECTRO DIESEL
466 70004 VESOUL: MECANIQUE GENERALE ET DIESEL
468 18108 VIERZON: ETS.FOUQUIAU

7

471 69517 VAULX EN VELIN CEDEX: ETS.BUSNENGO & CIE.
476 86001 POITIERS: ETS.BOURY

8

481 60202 COMPIEGNE CEDEX: AUTO SPECIALITE DE L'OISE
482 40990 SAINT PAUL LEX DAX: ETS.SARRAT & CIE.
483 43700 BRIVES CHARENSAC: DIESELEC FREINS DU VELAY
485 61300 L'AIGLE: TECHNICAUTO-CHARRON

9

498 31084 TOULOUSE CEDEX: ETS.CAMBUS & FILS

6. FRANKREICH, FRANCE, FRANCE, FRANZIA, FRANZIA,

D

0

501 73490 LA RAVOIRE-CHAMBERY: ETS.F.REY
502 74130 BONNEVILLE: ETS.HOMINAL
503 81100 CASTRES: GELABERT ELECTRO DIESEL
504 71380 SAINT MARCEL: A.G.A.C.
507 68200 MULHOUSE: SOCIETE NOUVELLE DU GARAGE DIESEL
509 13015 MARSEILLE: ETS.ANTONI

1

514 16103 COGNAC: ETS.L'HERITEAU ET CIE
519 57100 THIONVILLE: ETS.PIERRE THOME S.A.

2

520 83160 LA VALETTE DU VAR: S.A.F.I.A
523 29104 QUIMPER CEDEX: ETS.LOUIS ROUSSEL

3

531 41000 BLOIS: ETS.BOUCAUD & CIE.
532 81200 MAZAMET: MAZAMET ELECTRO DIESEL
533 67190 MUTZIG: AUTO ELECTRICITE ROBERT DAHLEN
537 87000 LIMOGES: AUTO SPECIALITES DU CENTRE

4

544 80700 ROYE: ETS.MME.G.POINTIN
546 35600 REDON: QUEST INJECTION
548 20601 BASTIA CEDEX: SUD DIESEL

5

551 93100 MONTREUIL: MONTREUIL DIESEL
555 37700 SAINT PIERRE DES CORPS: TOURS DIESEL
558 27300 BERNAY: ETS.CARBONNIER
559 14100 LISIEUX: LISIEUX-DIESEL

6

560 09100 SAINT-GIRONS: ETS.PIERRE JOUAS
561 11400 CASTELNAUDARY: ETS.PUEYO & CIE.
566 08000 CHARLEVILLE-MEZIERES: S.E.E.DES ETS.ROBERT DUTU

6. FRANKREICH, FRANCE, FRANCE, FRANCA, FRANCA,



7

571 80039 AMIENS: ETS.DEPARIS
572 83170 BRIGNOLES: BRIGNOLES ELECTRO DIESEL
574 42029 SAINT-ETIENNE: ETS.LAURENT PERE ET FILS

8

580 38170 SEYSSINET-PARISSET: S.E.T.A.I. - UNIGEP RHONES ALPES
581 90000 BELFORT: ATELIER ELECTRIC AUTO
582 29220 LANDERNEAU: E.U.R.L.ROGER RESFRIGET
583 26005 VALENCE CEDEX: DROME ELECTRO DIESEL
585 92230 GENNEVILLIERS: NATIONAL ELECTRIC
587 69006 LYON: ETS.MESSIN
589 68100 MULHOUSE: S.E.E.E.A.M.

9

590 95300 PONTOISE: OUEST DIESEL ELECTRIC
593 62510 ARQUES: ARQUES ELECTRO DIESEL
594 54404 LONGWY HAUT CEDEX: L.E.D.LONGAUTO
595 36400 LA CHATRE: ETS.ROGER GUILLEMAIN ET FILS
596 60300 SENLIS: SENLIS DIESEL
597 88000 EPINAL: ETS.ARNOLD & CIE.

6. FRANKREICH, FRANCE, FRANCE, FRANCA, FRANCA,



0

601 47240 BON ENCONTRE: C.T.A.D.F.
603 84000 AVIGNON: ETS.O.BERNARD
604 54002 NANCY CEDEX: SICARD, 2 RUE DE LA SALLE
606 76600 LE HAVRE: ETS.A.LEPETIT
608 57400 SARREBOURG: SARREBOURG DIESEL

1

610 59000 LILLE: C.E.A.DEBIEN
611 67500 HAGUENEAU: AUTO ELECTRICITE
614 94000 CRETEIL: GENERAL DIESEL ELECTRIC
616 31300 TOULOUSE: MIDI DIESEL
617 12200 VILLEFRANCHE DU ROUERGUE: ELECTRICITE DIESEL ROBERT PORTAL
618 53100 MAYENNE: ETS.A.PATRIE
619 89200 AVALLON: AUTO COMPTOIR DE L'YONNE

2

620 59506 DOUAI CEDEX: DOUAI DIESEL
622 95004 CERGY: ETS.GALLAYS
623 65000 TARBES: ETS.BLANCHARDET & CIE.
624 60300 SENLIS: C.E.T.I.F.
627 61200 ARGENTAN: DEMOLIN DIESEL
628 84120 PETRUIS: SERVICE DIESEL GU/ LIRON

3

631 37100 TOURS: ETS.R.MEXIA
632 57500 SAINT-AVOLD: SAINT AVOLD DIESEL
635 59800 LILLE: ATELIERS DE RECTIFICATION
639 86200 LOUDUN: ETS.TALBOT

4

640 74000 ANNECY: ELECTRO TECHNIC AUTO
643 29272 BREST CEDEX: ETS.FRANCOIS MEUNIER
644 35401 SAINT MALO CEDEX: AUTO INDUSTRIE MALOINE
645 16160 GOND-PONTOUVRE: ETS.JEAN MOURIOUX
646 17028 LA ROCHELLE CEDEX: SO.GE.RO.RA.
648 29130 QUIMPERLE CEDEX: RENOULT S.A.

5

651 35300 FOUGERES: ETS.LEMAITRE
652 29000 QUIMPER: ETS.JUSTAMANTE
653 17103 SAINTES CEDEX: SO.GE.RO.RA.
658 03400 YZEURE: ETS.RAY
659 45200 AMILLY MONTARGIS: ETS.BRAULT

6. FRANKREICH, FRANCE, FRANCE, FRANCAIA, FRANCAIA,



6

660 59406 CAMBRAI CEDEX: ETS. INFRELEC NEUVILLE
 661 58640 VARENNES VAUZELLE: NEVERS DIESEL ELECTRIC
 662 29234 PLOUIGNEAU: STE. BRETONNE MECANIQUE PRECISION
 663 17000 LA ROCHELLE: L'HERITEAU & CIE.
 664 15000 AURILLAC: AURILLAC ELECTRO DIESEL
 665 55101 VERDUN CEDEX: ETS. HERBEMONT S.A.
 666 52008 CHAUMONT CEDEX: S.N.O.M. SERVICE
 667 59140 DUNKERQUE: ETS. DRUEZ & FILS
 668 54520 LAXOU: NANCY RADIA
 669 59720 LOUVROIL: WASTRAETE ELECTRO-DIESEL

7

670 13015 MARSEILLE CEDEX 3: FREINAGE EQUIPEMENT
 671 71500 LOUHANS: ELECTRO DIESEL LASPALLE
 672 33240 SAINT ANDRE DE CUBZAC: SERVICE DIESEL ALCARAZ
 673 69007 LYON: ETS. LIGOUT
 674 61002 ALENCON CEDEX: F.I.A.O.
 675 01000 BOURG EN BRESSE: SOCIETE TECHNIQUE ELECTRO DIESEL
 676 56100 LORIONT: S.E.D.E.A.
 677 67500 HAGUENEAU: NORD EST DIESEL
 679 44400 REZE: AUTO PIECES NANTAIS

8

680 25600 FONTARLIER: STATION TECHNIQUE AUTOMOBILE
 681 25220 THISE: DIESEL ELECTRIC
 682 76200 DIEPPE: ETS. VAIN S.A.
 683 62400 BETHUNE: R.P.D.C.
 684 75020 PARIS: ETS. APARICIO
 685 91220 BRETIGNY SUR ORGE: S.E.M.B. SARL
 686 49800 TRELAZE: GARAGE RITQUET MERCIER
 688 29170 PLEUVEN: GARAGE YVES QUEMERE
 689 06130 GRASSE: ETS. GUEVAL

9

690 13100 AIX-EN-PROVENCE: ETS. R. BONDIL
 691 34700 LODEVE: STATION ELECTRIC AUTO
 692 13004 MARSEILLE: ELECTRICITE ELECTRONIQUE AUTO
 693 34000 MONTPELLIER: GARAGE ROBERT ALATI
 694 34540 BALARUC LES BAINS: STATION ELECTRO DIESEL MARTINEZ
 695 74380 BONNE: STATION ELECTRIC THABUIS
 696 38600 FONTAINE: S.E.E. AUTO LABO AUTO PIECES
 697 69190 SAINT FONS: ELECTRICITE AUTO LYON SUD
 698 67000 STRASBOURG: ELECTRICITE AUTO BAUMANN
 699 57190 FLORANGE: TECHNIQUE & SECURITE

6. FRANKREICH, FRANCE, FRANCE, FRANCAIA, FRANCAIA,



0

700 70100 ARC LES GRAY: AUTO TECHNIC
 701 57120 CLOUANGE: ORNE ELECTRO DIESEL
 702 26100 ROMANS: ELECTRICITE AUTO
 703 30000 NIMES: NIMES DIESEL
 705 89300 JOIGNY: STATION ELECTRIC AUTO
 706 45300 PITHIVIERS: GARAGE MICHEL BARRE
 707 60670 LAIGNEVILLE: GARAGE PLESSIER
 708 92230 GENNEVILLIERS: STATION REDONDIN
 709 76340 BLANGY SUR BRESLE: GARAGE CHEVALLIER JACQUES

1

710 11300 LIMOUX: ELECTRICITE AUTO COURTADE
 711 11500 QUILLAN: ELECTRICITE AUTO DIESEL
 712 66600 RIVESALTES: ELECTRICITE AUTO
 713 91300 MASSY: TECHNIC AUTO
 714 91100 CORBEIL: SEDEN ELECTRICITE AUTO
 715 91200 ATHIS MONS: ATHIS MONS ELECTRIC AUTO
 716 77650 JUTIGNY: S.A. TECHNIC REPAR
 717 86000 POITIERS: BEAULIEU GARAGE J. DRYA
 718 86470 LAVAUSSEAU: GARAGE D. GUILBARD
 719 74000 ANNECY: TECHNIC AUTO

2

720 01200 BELLEGARDE: ELECTRIC AUTO
 721 21560 COUTERNON: CENTRE TECHNIQUE MOBILE
 722 69530 BRIGNAIS: ELECTRIC AUTO
 723 73100 AIX LES BAINS: ETS. GALLET
 724 76500 ELBOEUF: ETS. LETHIAIS
 725 60800 CREPY EN VALOIS: CREPY ELECTRIC AUTO
 726 08300 RETHEL: ETS. GERARD GUILLAUME
 727 11100 NARBONNE: SERVICE ELECTRO DIESEL
 728 11200 LEZIGNAN-CURBIERES: ETS. R. CASTEL
 729 11800 TREBES: ELECTRICITE AUTO RAZOUS

3

730 66200 ELNE: ELECTRIC AUTO
 731 69330 MEYZIEU: GARAGE SPALVIERI
 733 46130 BRETENOUX: ELECTRICITE AUTO
 735 31140 AUCAMVILLE: S.E.E. FABREGAS
 736 80100 ABBEVILLE: ETS. SIMON
 737 95000 CERGY NORD: CERMECA
 738 75014 PARIS: MIRAMOND DAN AUTO

6. FRANKREICH, FRANCE, FRANCE, FRANCA, FRANCA,



4

740 38308 BOURGOIN-JALLIEU CEDEX: ISERE INJECTION
741 74100 ANNEMASSE: A.T.E.A.
742 12000 RODEZ: ETS.PIERRE RAYNAL
743 92700 COLOMBES: S.M.D.A.
744 95100 ARGENTEUIL: ARGENTEUIL DIESEL ELECTRIC
746 69220 BELLEVILLE SUR SAONE: BELLEVILLE ELECTRO DIESEL
747 69009 LYON: ELECTRICITE AUTOMOBILE
748 77360 TORCY: TORCY ELECTRO INJECTION
749 82002 MONTAUBAN: VIDAL ELECTRO DIESEL

5

750 14800 DEAUVILLE: ELECTRIC AUTO
751 34000 MONTPELLIER: S.A.R.M.E.G.
752 84800 L'ISLE SUR SORGUE: STATION INJECTION DIESEL
753 84350 COURTHEZON: ETS.CAPRINI
754 86002 POITIERS: ETS.MONTAJAULT
755 67460 SOUFFELWEYSHEIM: GARAGE KERN S.A.
756 13400 AUBAGNE: STATION ELECTRIQUE
757 92300 SCEAUX: ETS.LAGARDE
758 35400 SAINT MALO: ROME ELECTRO DIESEL
759 84300 CAVAILLON: ETS.RICARD & CIE.

6

760 44470 CARQUEFOU: OUEST INJECTION
761 14120 MONDEVILLE: ETS.RAGUES
762 24220 SAINT CYPRIEN: PERIGORD REGLAGE AUTO
763 42300 ROANNE: ELECTRIC'AUTO THOMAS
764 42390 VILLARS: SAINT ENTIENNE ELECTRO DIESEL
765 44800 SAINT HERBLAIN: ETS.LETENDRE
766 49500 SEGRE: ETS.H.GODIVEAU
767 62170 MONTREUIL SUR MER: MONTREUIL ELECTRO DIESEL
768 64100 BAYONNE: ATELIER ELECTRO DIESEL
769 90000 BELFORT: GARAGE PY

7

770 33470 GUJAN MESTRAS: ELECTRIC STATION
771 13700 MARIGNANE: ELECTRIC AUTO
772 13004 MARSEILLE: CHECK'UP AUTO
773 06800 CAGNES SUR MER: ELECTRIC AUTO
774 06240 BEAUSOLEIL: ETS.BARRET
775 06600 ANTIBES: ELECTRIC AUTO
776 75116 PARIS: ELECTRIC AUTO
777 6120 MANDELJEU: FERBEC AUTOMOBILES
778 83700 SAINT RAPHAEL: ELECTRICITE MECANIQUE
779 06400 CANNES: ELECTRICITE AUTO PARENT

6. FRANKREICH, FRANCE, FRANCE, FRANCA, FRANCA,



8

780 06110 ROCHEVILLE: ELECTRICITE AUTO YVON
781 68800 THANN: BLONDEL SERVIE
782 24100 BERGERAC: FRANC DIESEL
784 59278 ESCAUTPONT: ETS.R.MONDIN S.A.
786 83260 LA CRAU: INJECTRONIC
789 63200 RIOM: SNC D'AGOSTIN FRERES

9

790 05000 GAP: GAP ELECTRONIC AUTO
792 74200 THONO: ETS.MARCE

6. FRANKREICH, FRANCE, FRANCE, FRANCA, FRANCA,

D

5
854 54840 GONDREVILLE: SICARD, PARC DE HAYE ROUTE DE PARIS

6. FRANKREICH, FRANCE, FRANCE, FRANCA, FRANCA,

D

0
901 93450 L'ILLE SAINT-DENIS: F.G.H.P.
903 94100 SAINT MAUR: S.A.E.

1
910 38140 RIVES SUR FURE: DURAND SERVICE AUTO
912 81000 ALBI: ELECTRICITE AUTOMOBILE
913 04100 MANOSQUE: TECHNI SUD AUTO
914 22360 LANGUEUX: BOUTIQUE AUTO CONFORT
915 38150 ROUSSILLON: ETS.MAGNIAT
916 52100 SAINT DIZIER: LAMBERTH ELECTRICITE AUTO
917 66000 PERPIGNAN: ACCOR
919 01890 BETTANT: BUGEY DIESEL

2
920 32000 AUCH: SERVICE TECHNIQUE INJECTION
921 81000 ALBI: GRIMAL DIESEL
922 34500 BEZIERS: STATION INTER DIESEL
923 62300 LENS: ETS.LEDRU
924 94000 CRETEIL: AUTO STATION TECHNIC
925 83170 BRIGNOLES: SPEED-CAR
926 42300 ROANNE: BESSON RECONSTRUCTION MOTEURS
928 31600 MURET: ETS.PIERRE SARA

3
930 11100 NARBONNE: ETS.SUBRA A. & FILS
934 25400 EXINCOURT: ETS.BOURLIER
935 7700 MEAUX: KALAMAR
936 51000 CHALONS SUR MARNE: D. I. E. C.

4
948 131170 LES PENNES MIRABEAU: D.E.GRILLON, RN 113
949 13000 MARSEILLE: 6 BLD.DE LA RAFFINERIE

5
950 33000 BORDEAUX: FOURNI AUTO, 129 RUE DU DOCTEUR A.BARREAUD
951 33130 BEGLES: COMTOIR DE REPRESENTATION, Z.I.DE TARTIFUME
952 94200 IVRY: I.D.L.P., 32-34 RUE HOCHÉ
953 78153 LE CHESNAY CEDEX: S.C.A.A., RUE MOXOURIS

7. ITALIEN, ITALY, ITALIE, ITALIA, ITALIA,

A

IAF 57100 LIVORNO (LI): ROYALTIES DI CARNELOSSO
 IAG 57100 LIVORNO (LI): PISCITELLI MARIO
 IAH 58010 ORBETELLO (GR): O.R.A. OFF. RIP. AUTOCARRI
 IAI 58054 SCANSANO (GR): SALVADDRI CARLO
 IAJ 58017 PITIGLIANO (GR): LIBERATI CARLO
 IAK 58100 GROSSETO (GR): CIABATTI & BONCIOLI
 IAL 58022 FOLLONICA (GR): VANNONI FURIO
 IAM 58010 ALBINIA (GR): SEM DI BRACCIALI & TOSINI
 IAN 58100 GROSSETO (GR): BORGHI FOSCO
 IAO 58048 PAGANICO (GR): NARDI FRANCO
 IAP 58100 GROSSETO (GR): BURIANI SNC ELETTR.
 IAR 58100 GROSSETO (GR): CONTI & CAZZIOLATO SNC
 IAS 58100 GROSSETO (GR): ELETTRAUTO TONINI & GORI
 IAT 57029 VENTURINA (LI): G.V.P. OFF. ELETT. SNC
 IAV 58100 GROSSETO (GR): BIANCHINI F. & FALCINI F.
 IAX 58022 FOLLONICA (GR): MACRI' RAFFAELE
 IAY 57100 LIVORNO (LI): SCOTTI GIORGIO

B

IBB 57023 CECINA (LI): SARDI RENATO
 IBC 57013 ROSIGNANO SOLVAY (LI): BONGINI NUBIANO
 IBD 55040 STIAVA (LU): GIANNOTTI RENZO
 IBG 58100 GROSSETO (GR): BINDI ALBANO
 IBH 55049 VIAREGGIO (LU): PAOLI SAURO ELETTR.
 IBL 56025 PONTEDERA (PI): MARTINI LUCIANO
 IBM 58100 GROSSETO (GR): TANGANELLI & STOFFA
 IBO 57017 STAGNO (LI): BERRETTA & BERNINI

D

IDA 55100 LUCCA (LU): ELETTR. MARRACINI & SALVETTI
 IDB 55011 ALTOPASCIO (LU): ELETTRODIESEL MARCHESCHI
 IDD 55042 FORTE DEI MARMI (LU): GARAGE IMPERIALE
 IDE 55043 LIDO DI CAMAIORE (LU): LEMMETTI FRANCO
 IDF 55049 VIAREGGIO (LU): DUCCINI FRANCO
 IDG 55050 BOZZANO (LU): ELETTRAUTO BOZZANO DI MEI G.
 IDH 56021 CASCINA (PI): GIANFALDONI F. LLI SNC
 IDI 55046 QUERCETA (LU): POLI ELIO
 IDL 54100 MASSA (MS): MAZZI ALBERTO
 IDM 56029 S.CROCE S/ARNO: TOSCANA DIESEL SNC
 IDN 54031 AVENZA (MS): ELETTRAUTO PIERO SNC
 IDO 56100 PISA (PI): BERNICCHI & C.
 IDP 56031 BIENTINA (PI): MATTEOLI & FILIDEI SDF ELETTR.
 IDS 56014 OSPEDALETTO (PI): ELETTRODIESEL PISANA SDF
 IDU 56025 PONTEDERA (PI): MAGRETTI CARLO
 IDW 56021 CASCINA (PI): BECONCINI & PANTANI
 IDX 55010 LUNATA (LU): ELETTR. MARRACCINI & GHISELL
 IDY 75025 POLICORO (MT): NUZZI ANTONIO AUTOFFICINA

7. ITALIEN, ITALY, ITALIE, ITALIA, ITALIA,

E

IEA 55054 MASSAROSA (LU): DINI SAURO
 IEB 54100 MASSA C. FRAZ. ROMAGNA: NICOLINI MARCO
 IEC 56030 PERIGNANO (PI): ELETTR. DI BILIA VANNUCCHI
 IED 58100 GROSSETO (GR): DRAGHI SILENO & C. SNC
 IEE 58024 MASSA MARITTIMA (GR): BOCCARDI GIANCARLO
 IEF 55026 CHIFENTI/BGO MOZZANO: LUVISI GIUSEPPE
 IEG 55045 PIETRASANTA (LU): COSTA MARCO
 IEH 55049 VIAREGGIO (LU): SORBI PIERO & C. SNC
 IEI 56100 PISA (PI): MANNUCCI & DOVERI
 IEJ 56012 FORNACETTE (PI): FERRETTI EDO
 IEK 56010 MADONNA DELL'ACQUA (PI): GALLI PIETRO & FIGLI SNC
 IEL 56038 FONSACCO (PI): CIONI & MACELLONI SDF

F

IFA 60125 ANCONA (AN): FIORI & LODOLINI SNC
 IFC 60035 JESI (AN): AMADIO GIUSEPPE & C. SNC
 IFD 60035 JESI (AN): FILENI F. LLI SNC
 IFE 60125 ANCONA (AN): BISOGNI MORBIDONI & C. SNC
 IFF 60128 ANCONA (AN): CARFANO MARCELLO ELETTRAUTO
 IFG 63039 S. BENEDETTO DEL TR.: ERCOLE ARMANDO ELETTR.
 IFH 63037 PORTO D'ASCOLI (AP): DE ASCANIIS ALDO
 IFI 63018 PORTO S. ELPIDIO (AP): ELETTR. DIESEL 2000 RECCHIONI
 IFJ 60027 OSIMO (AN): CASONI MARIO
 IFK 61100 PESARO (PS): GOTTARDI GIORGIO & C. SNC
 IFL 61100 PESARO (PS): ZENO SNC ELETTR.
 IFM 61041 ACQUALAGNA (PS): CONTI FRANCO
 IFN 61032 FANO (PS): UGUCCIONI & MENCUCCI & C. SNC
 IFO 61047 SAN LORENZO CAMPO (PS): BONAFEDE LORENZO
 IFP 61027 VILLA FASTIGGI (PS): FERRI MARCELLO & PEZZOLESI M
 IFS 61030 LUCREZIA (PS): GAMBELLI & OMICCIOLI SNC
 IFT 61040 MONTEPORZIO (PS): TESTAGUZZA & GIAMMATTEI
 IFW 60131 ANCONA (AN): OFF. PRIFA SNC DI MEZZABOTTA
 IFX 60125 ANCONA (AN): FIGLIAPOCO GIULIO & C.
 IFY 62100 MACERATA (MC): MACCARI & MARANGONI SNC
 IFZ 60015 FALCONARA MARITTIMA (AN): CATANI GIOVANNI

G

IGA 60010 RIPE (AN): MORGANTI LINO
 IGB 63100 ASCOLI PICENO (AP): O.R.F.A.
 IGC 63100 ASCOLI PICENO (AP): NOVA TURBO DIESEL DI PALMA
 IGE 63037 PORTO D'ASCOLI (AP): CURZI GIOVANNI & C. SNC
 IGF 63100 ASCOLI PICENO (AP): MONTANI EMIDIO & C. SNC
 IGG 62012 CIVITANOVA MARCHE (MC): BUSCARINI GIORGIO
 IGH 63030 CASTORANO (AP): LELLI ERMINIO
 IGI 61100 PESARO (PS): ANGELONI SANCHIONI SRL
 IGJ 61032 FANO (PS): CANDELORI GIORGIO
 IGK 63039 S. BENEDETTO DEL TR.: UNITEST
 IGL 62010 SFORZACOSTA (MC): CARACENI ERALDO & SILVANO SN
 IGN 65015 MONTESILVANO (PE): ELETTR. DIESEL DI VITO D.

7. ITALIEN, ITALY, ITALIE, ITALIA, ITALIA,

I

IIA 85043 LATRONICO (FZ): FALABELLA EGIDIO
 IIB 06100 PERUGIA (PG): ELETTRODIESEL
 IIC 06100 PERUGIA (PG): LATTAIOLI & BISCARINI
 IID 06100 PERUGIA (PG): NERI LINO
 IIE 06083 BASTIA UMBRA (PG): PIERI & VETTURINI SNC
 IIF 06083 BASTIA UMBRA (PG): ROSSETTI & MORABITO
 IIG 06012 CITTA CASTELLO (PG): ELETTRODIESEL BARBETTI SNC
 IIH 06034 FOLIGNO (PG): GNOZZA MICHELE
 III 06063 MAGIONE (PG): ORECCHINI CESARE
 IIJ 06059 TODI (PG): BAGLIONI & TORTOIOLI SNC
 IIL 06087 PONTE SAN GIOVANNI (PG): CIACCIO ELVIO
 IIM 06074 ELLERA UMBRA (PG): ELETTRAUTO MANCINI ILVANO SN
 IIN 06049 SPOLETO (PG): PACCHIA ANTONIO
 IIO 06024 GUBBIO (PG): PICCOTTI & MONACELLI
 IIP 05019 ORVIETO (TR): FROSININI VINCENZO & C. SNC
 IIR 06061 CASTIGLIONE LAGO (PG): MASTRINI GIANCARLO
 IIT 06033 CANNARA (PG): ELETTRAUTO SNC FILIPPUCCI OT
 IIV 05019 ORVIETO SCALO (TR): L'ELETTRODIESEL SNC
 IIY 70013 CASTELLANA GROTTA (BA): DI MASI PAOLO & C.
 IIZ 06083 BASTIA UMBRA (PG): NUOVA ELETTRODIESEL

J

IJA 06034 FOLIGNO (PG): INFUSSI ALVEND
 IJB 06023 GUALDO TADINO (PG): MONACELLI GIUSEPPE
 IJC 05100 TERNI (TR): FERRENTINO BIAGIO
 IJD 05100 TERNI (TR): LAMPERINI ARMANDO
 IJE 05036 NARNI SCALO (TR): LE-DON F. LLI PANEZI & C. SNC
 IJF 70023 GIOIA DEL COLLE (BA): SIRRESSI MICHELE
 IJG 05100 TERNI: F.LLI PILERI DI PILERI
 IJH 05019 ORVIETO SCALO (TR): L'AUTOELETTRICA DI CIUCCI
 IJI 00136 ROMA: AUTOSYSTEM SNC
 IJK 00182 ROMA: A.T.E.D.
 IJL 00135 ROMA: PETRACCINI GIORGIO
 IJM 00146 ROMA: MASSARI MARIO CENTRO ELET.
 IJY 00133 ROMA: DI PIETRO GIANCARLO

K

IKA 00157 ROMA (ROMA): C.A.E. SNC DI TADDEI R. & C.
 IKB 00184 ROMA (ROMA): GALLI PIERGIORGIO
 IKC 00195 ROMA (ROMA): AUTOCENTRO PRATI S.R.L.
 IKD 00167 ROMA (ROMA): AUTOTEC. RASTELLI-COSTA
 IKE 00182 ROMA (ROMA): BARBIERI ROBERTO
 IKF 00176 ROMA (ROMA): BASSI AGOSTINO
 IKG 00172 ROMA (ROMA): BARBIERI ROMANO
 IKH 00057 MACCARESE (ROMA): GISCI ROBERTO
 IKI 00048 NETTUNO (ROMA): DE CESARIS G.B. ELETTRAUTO
 IKJ 00056 OSTIA LIDO (ROMA): CAUSIO ROCCO
 IKK 00188 PRIMA PORTA (ROMA): ELETTRODIESEL SNC
 IKM 00053 CIVITAVECCHIA (ROMA): PAOLUCCI PRIMO

I 03

7. ITALIEN, ITALY, ITALIE, ITALIA, ITALIA,

K

IKN 00012 SETTEVILLE GUID. (ROMA): D.R.E.D. PENNA & SPARACCA
 IKO 00146 ROMA (ROMA): COLAIACOMO A. & A. SNC
 IKP 00167 ROMA (ROMA): CARAMANNA & C. SNC
 IKR 00146 ROMA (ROMA): BONDANINI FRANCO & C. SNC
 IKS 00191 ROMA (ROMA): CAPOCCI ATTILIO SRL
 IKT 00135 ROMA (ROMA): CAPPUCCIO ENZO
 IKU 00163 ROMA (ROMA): FIANESI & ESPOSITO SNC ELET.
 IKW 00194 ROMA (ROMA): CRUCIANI CARLO
 IKX 00159 ROMA (ROMA): NECCI AMLETO
 IKY 00154 ROMA (ROMA): D'ORAZI VIVALDO
 IKZ 00154 ROMA (ROMA): O.E.R.P.I. DI LOTTI G.

L

ILA 00154 ROMA (ROMA): PASQUALI ITALO
 ILB 00147 ROMA (ROMA): ELETTRCAR SRL
 ILD 00177 ROMA (ROMA): SEMPRINI GIANCARLO
 ILE 00151 ROMA (ROMA): AUTOCENTRO VILLA FLORA
 ILF 00157 ROMA (ROMA): TORREGGIANI ROLANDO
 ILG 00148 ROMA (ROMA): SCORZONI ROBERTO ELETTRODIESEL
 ILH 00133 ROMA (ROMA): BIDINI FULVIO
 ILI 00154 ROMA (ROMA): CANCELLARA NICOLA
 ILK 00173 ROMA (ROMA): C.E.D. SNC ELETTRD.
 ILL 00152 ROMA (ROMA): CICINI GIUSEPPE
 ILM 00148 ROMA (ROMA): DORINZI MAURO
 ILN 00162 ROMA (ROMA): GRAND PRIX SRL
 ILO 00166 ROMA (ROMA): CHIOFALO SALVATORE
 ILP 00163 ROMA (ROMA): DE SARIO - BELLO - ANDREONI
 ILR 00157 ROMA (ROMA): GHISU MICHELE
 ILT 00167 ROMA (RM): FITZOLU CARBURATORI
 ILU 00028 SUBIACO (ROMA): PELLICCIA LUIGI
 ILV 04011 APRILIA (LT): MARINO GIUSEPPE RETTIFICA
 ILX 00144 ROMA (ROMA): EURWAGEN S.R.L.
 ILY 00041 ALBANO LAZIALE (ROMA): BUCCIARELLI ENZO
 ILZ 00191 ROMA (ROMA): GAMMA 1 S.R.L.

M

IMA 00040 ARDEA (ROMA): SGUERA SERGIO OFF. P.DIESEL
 IMB 00191 ROMA (ROMA): PENTA DIESEL S.R.L.
 IMC 00040 POMEZIA (ROMA): GALLIA LIVIO
 IMD 00049 VELLETRI (ROMA): SERANGELI DIESEL SDF
 IMF 00142 ROMA (ROMA): OFF. CAR LAURENTINA SRL
 IMG 00165 ROMA (ROMA): SEVEN AUTO S.R.L.
 IMH 00043 CIAMPINO (ROMA): CARA DUILIO
 IMI 00141 ROMA (ROMA): FARINA & PETRONGOLO
 IMJ 00195 ROMA (ROMA): E.D. DI FEDERICI
 IMK 00139 ROMA (ROMA): ELETTRODIESEL 85 DI RUCO & C.
 IMM 00034 COLLEFERRO (ROMA): ARCHILLETI ANTONIO
 IMN 00174 ROMA (ROMA): MACUTAN ENZO
 IMO 00183 ROMA (ROMA): D.E.A. S.R.L.

I 04

7. ITALIEN, ITALY, ITALIE, ITALIA, ITALIA,

M

IMS 00054 FIUMICINO (ROMA): PASQUALI LIVIO
 IMT 00179 ROMA (ROMA): CAMPOLUCCI GIANCARLO
 IMU 03100 FROSINONE (FR): SELLARI UMBERTO
 IMV 03100 FROSINONE (FR): SARTORI GIUSEPPE
 IMW 03037 PONTECORVO (FR): BRAICO GIOVANNI
 IMY 00177 ROMA (ROMA): SEMPRINI LUCIANO
 IMZ 04100 LATINA (LT): ELETTR. BOLOGNESE SNC

N

INA 04019 TERRACINA (LT): NUOVA OFF. ELETTR. PANNOZZI
 INB 04012 CISTERNA LATINA (LT): PRIORI LIVIO ELETTRODIESEL
 INC 04011 APRILIA (LT): DE CAROLIS F.LLI
 IND 04014 PONTINIA (LT): COLANDREA GIOVANNI
 INE 02100 RIETI (RI): BRUNELLI GIANFRANCO
 INF 00134 ROMA (ROMA): BONDANINI BRUNO
 ING 00034 COLLEFERRO (ROMA): STURVI ROMOLO & C.
 INH 00048 NETTUNO (ROMA): MONTAGNA VITTORIO
 INI 00016 MONTEROTONDO S. (ROMA): ZANGA GASTONE
 INJ 00040 POMEZIA (ROMA): PRIORI MAURIZIO
 INK 00011 BAGNI DI TIVOLI (ROMA): P.T.F. SNC DI FIRLI & TRANQUILLI
 INL 00060 S.MARIA DI GALERIA (ROMA): DI PALMA ORAZIO & ISOLIERO
 INM 00199 ROMA (ROMA): CENTRO ASSISTENZA MB
 INN 00174 ROMA (ROMA): C.M. DI CIRIACHI CLAUDIO
 INO 00135 ROMA (ROMA): DE CAROLIS & VASIRANI S.D.F.
 INP 00179 ROMA (ROMA): GRILLI SAURO
 INR 00173 ROMA (ROMA): PISTONESI PAOLO
 INS 03100 FROSINONE (FR): LAB. APPARATI DIESEL
 INT 03043 CASSINO (FR): ORPID DI LOMBARDO & C. S.D.F.
 INU 03100 FROSINONE (FR): MASCETTI GIUSEPPE
 INV 04011 APRILIA (LT): PALOMBO FABRIZIO
 INW 04023 FORMIA (LT): AMENDOLA BRUNO
 INX 04019 TERRACINA (LT): CAPRARO PASQUALE
 INY 04100 LATINA (LT): BUERRA MICHELE
 INZ 04100 LATINA (LT): TIMOTINI ANGELO

O

IOA 04022 FONDI (LT): ROTONDO FRANCO
 IOB 02100 RIETI (RI): FAGIOLO PAOLO & G. S.D.F.
 IOC 00139 ROMA (ROMA): LUCIGNANO SALVATORE
 IOD 00053 CIVITAVECCHIA (ROMA): LOMBI ARMANDO
 IOE 00049 VELLETRI (ROMA): ELETTRAUTO LEONI FRANCO
 IOF 04100 LATINA (LT): OSPIL SDF
 IOH 04010 BORG SAN MICHELE (LT): LATINA DIESEL SNC
 IOJ 04022 FONDI (LT): AUTOELETTRA F. LLI MATTEOLI S.
 IOL 00198 ROMA (ROMA): AUTOFFICINA PORTA PIA
 IOM 00179 ROMA (ROMA): ZOPPI EDOARDO & FIGLI
 ION 00182 ROMA (ROMA): ESPOSITO & ORTIERI SNC
 IOO 00176 ROMA (ROMA): FEDE BRUNO
 IOF 00166 ROMA (ROMA): GIOVINAZZO GEROLAMO

7. ITALIEN, ITALY, ITALIE, ITALIA, ITALIA,

O

IOR 00134 ROMA (ROMA): PAPPARUSSO FRANCO
 IOS 00054 FIUMICINO (ROMA): SASSO PAOLO
 IOT 00052 CERVETERI (ROMA): BENFATTI GIOVANNI
 IOU 00064 CESANO DI ROMA (ROMA): RICCITELLI FERNANDO & CO.
 IOV 00045 GENZANO (ROMA): AUTOFF. NANDO SNC DI SENESI
 IOW 00045 GENZANO (ROMA): F.LLI CASTAGNA SNC ELETTR.
 IOX 00045 GENZANO (ROMA): RUSSI GIANNI
 IOY 00015 MONTEROTONDO (ROMA): STRALLO OSVALDO
 IOZ 00121 OSTIA LIDO (ROMA): LANINI SERGIO

P

IFA 00036 PALESTRINA (ROMA): TOPANI PIETRO
 IFB 00199 ROMA (ROMA): ARAV & C. SNC

R

IRA 01023 CIVITACASTELLANA (VT): CENSI CESIO
 IRB 01013 CURA VETRALLA (VT): ZACCANI CARLO
 IRC 01028 ORTE (VT): SCIARRA MARIO
 IRD 01017 TUSCANIA (VT): SANTUCCI FRANCO
 IRE 00049 VELLETRI (ROMA): JUNIOR GAS IMPIANTI
 IRF 01016 TARQUINIA (VT): BLANCHI ANTONIO
 IRG 01027 MONTEFIASCONE (VT): BERBEGLIA ENRICO
 IRI 01100 VITERBO (VT): BERNINI MARIO & SERGIO
 IRJ 01100 VITERBO (VT): D'OTTAVIO F.LLI
 IRK 01100 VITERBO (VT): VALLERIANI PERICLE
 IRL 01036 NEPI (VT): CRESCA MARIO
 IRM 01100 VITERBO (VT): PICCA ALBERTO
 IRN 01036 NEPI (VT): ANDREOLI CLAUDIO

S

ISA 86042 CAMPOMARINO (CB): CARINGELLA ENZO
 ISB 65010 SPOLTRE-VILLA RASPA: TROIANO & ZAMPACORTA
 ISC 65100 PESCARA (PE): SFERRELLA & RENZETTI SNC
 ISD 66013 CHIETI SCALO (CH): BELFIGLIO MICHELE & C. SNC
 ISE 65126 PESCARA (PE): DI MARCELLO & MENNA SNC
 ISG 86039 TERMOLI (CB): FREGUGLIA DANILO
 ISH 86100 CAMPOBASSO (CB): PARZIALE MICHELE
 ISJ 86039 TERMOLI (CB): CAPOSIENA & ARDANESE
 ISK 86021 BOIANO (CB): TAMBURRI ANTONIO
 ISM 66030 MOZZAGROGNA: CERRONE MARIO
 ISN 66041 ATESSA (CH): TUCCI NICOLA
 ISO 68043 CASOLI (CH): D'ALONZO DOMENICO & CAMILLO
 ISP 66010 SAN MARTINO MARRUCINA: MASCIARELLI ROCCO
 ISR 66034 LANCIANO (CH): TADDEO BRUNO
 ISS 64020 VAL VOMANO (TE): DI GREGORIO GABRIELE
 IST 66040 PIAZZANO DI ATESSA (CH): D'ALONZO DOMENICO
 ISU 66020 SAMBUCETO (CH): ADVANCE ELETTRODIESEL

7. ITALIEN, ITALY, ITALIE, ITALIA, ITALIA,

S

ISV 66054 VASTO (CH): LABBATE OSVALDO
 ISW 86170 ISERNIA (IS): SCRICCA ANGELO & C. SNC
 ISX 67051 AVEZZANO (AQ): ROSSI FULVIO
 ISY 67031 CASTEL DI SANGRO (AQ): CATULLO GIULIO ELETTRAUTO

T

ITA 62010 CINGOLI (MC): BRANCHESI CORRADO
 ITB 00144 ROMA: MAZZARINI DANIELE
 ITC 00119 DRAGONA ACILIA (ROMA): MORETTO SERGIO
 ITD 83050 CASTELFRANCI (NA): Malfetano ANTONIO
 ITF 64020 SAN NICOLO A TORDINO: MARRANCONE OLIVIERO
 ITM 74022 FRAGNANO (TA): MAZZA FRANCESCO & FIGLI
 ITN 86100 CAMPOBASSO (CB): BERCHICCI GIOVANNI
 ITO 66023 FRANCAVILLA (CH): CATENA LUIGI
 ITS 86170 ISERNIA (IS): TROMBA PASQUALE
 ITT 67100 L'AQUILA (AQ): GABRIELLI RENZO
 ITU 67051 AVEZZANO (AQ): ADANI CARLO & C. SDF
 ITV 64100 TERAMO (TE): 2 P. DI PIERANNUNZIO M. & C.
 ITX 64026 ROSETO ABRUZZI (TE): LOZZI & DE LEONARDIS SNC
 ITY 66023 FRANCAVILLA MARE (CH): F.LLI CONTROGUERRA & C. SNC

U

IUS 84025 EBOLI (SA): REAL DIESEL SDF DI ANSALONE

V

IVA 80141 NAPOLI (NA): CARD SRL CREMONESE & C. SNC
 IVB 80146 NAPOLI (NA): CRISCUOLO LUIGI
 IVC 80137 NAPOLI (NA): VITTORIA SRL ELETTRAUTO
 IVD 80142 NAPOLI (NA): LOSCHI DI E. LOSCHI & C. SNC
 IVE 80131 NAPOLI (NA): E.A.C. DI MADDALONI
 IVF 80143 NAPOLI (NA): SCHISANO & GAVEGLIA SNC
 IVG 80125 NAPOLI (NA): STANZIONE ANTONIO
 IVH 80018 MUGNANO (NA): LICCARDO ALDO
 IVI 80021 AFRAGOLA (NA): CASABURO & MORMILE
 IVJ 80054 GRAGNANO (NA): MARINARO LUIGI
 IVL 84010 SAN VALENTINO TORIO: LONGOBARDI ANTONIO & C. SNC
 IVM 80132 NAPOLI (NA): SAGLIOCCHI MARIO
 IVN 80123 NAPOLI (NA): ESPOSITO GIOACHINO
 IVP 80026 CASORIA (NA): SODANO GIOVANNI
 IVR 80128 NAPOLI (NA): CAIAZZA GIUSEPPE
 IVV 83100 AVELLINO (AV): GIANNETTI MARIO
 IVW 83047 LIONI (AV): TUOSTO ANGELO
 IVY 83100 AVELLINO (AV): IANNACCONE MODESTINO
 IVZ 83030 PASSO ECLANO (AV): DI PLACIDO MICHELE

7. ITALIEN, ITALY, ITALIE, ITALIA, ITALIA,

W

IWA 82100 BENEVENTO (BN): BEATRICE ALFREDO
 IWB 80035 NOLA (NA): MELE LUIGI
 IWC 80063 PIANO DI SORRENTO (NA): ELETTRDIESEL SNC
 IWD 80055 PORTICI (NA): BEST CAR SERVICE
 IWE 80055 PORTICI (NA): CAPRICANO ROSARIO
 IWF 81059 VAIRANO SCALO (CE): DEL VECCHIO ANTONIO
 IWG 80126 PIANURA (NA): PIETROLUONGO VINCENZO
 IWH 80039 SAVIANO (NA): STROCCHIA CARMINE
 IWI 84100 SALERNO (SA): SANTORO OTTAVIO
 IWJ 84100 SALERNO (SA): RICCIARDI MICHELE
 IWL 84030 PADULA S. (SA): ROTUNNO GIUSEPPE
 IWM 86065 CORIGLIANO STAZ. (CS): FALBO & FRONTERA
 IWN 83030 MIRABELLA-PASSO ECLANO: PESCATORE & MARTUCCI
 IWO 84091 BATTIPAGLIA (SA): CARBONE RAFFAELE
 IWP 83018 S. MARTINO V. CAUDINA: O.M.E.S. SPULZO P. & F. LLI SNC
 IWS 84012 ANGRI (SA): AUTOFERRARA SAS
 IWT 80146 NAPOLI (NA): CONTIELLO LUIGI SNC
 IWU 80144 NAPOLI (NA): F.A.D.E.S.
 IWV 80124 NAPOLI (NA): ALBERTO SILVIO DI ALBERTO M.
 IWW 80057 S. ANTONIO ABATE (NA): DELMA
 IWX 80144 NAPOLI (NA): MARANO STEFANO & C. SNC
 IWY 80019 QUALIANO (NA): OFF. PICCOLO SNC
 IWZ 80037 PIAZZOLA DI NOLA (NA): CORCIONE ESPOSITO V.

X

IXA 83010 MERCOGLIANO (AV): CORRADO UGO
 IXB 85043 LATRONICO (PZ): CARICATI EGIDIO
 IXC 82100 BENEVENTO (BN): SPULZO CIRO & PASQUALE SNC
 IXD 70123 BARI (BA): CALABRIA EMILIO & SAVERIO
 IXF 81055 S. TA MARIA C. VETERE: S.A.P.I. DI BRANCO
 IXG 84063 PAESTUM (SA): TOLOMED ANGELO
 IXH 83048 MONTELLA (AV): VOLPE FELICE
 IXI 70013 CASTELLANA GROTTA (BA): SGOBBA BARTOLOMEO
 IXJ 84014 NOCERA INFERIORE (SA): CITARELLA RAFFAELE
 IXK 85100 POTENZA (PZ): RANIERI PAOLO
 IXL 84012 SANT'EGIDIO MONTALBINO: SETARO FRANCESCO
 IXM 84014 NOCERA INFERIORE (SA): FALLADINO ANTONIO
 IXN 84036 SALA CONSILINA (SA): DIESEL TEC. SPOLZINO SNC
 IXO 80026 CASORIA/LA CITTADELLA: ORFI DI DOGANIERO NICOLA
 IXP 83029 SOLOFRA (AV): CERRATO EMILIO & C. SNC
 IXR 84081 BARONISSI (SA): SO.ME.D SRL CARMINE & MARZIO
 IXS 82016 MONTESARCHIO (BN): NAZZARO ALDO
 IXU 85029 VENOSA (PZ): COSCIA VITO OFF.
 IXV 81038 TRENTOLA DUCENTA (CE): VESPINI LUIGI
 IXW 84091 BATTIPAGLIA (SA): VEA SUD SNC
 IXX 84025 EBOLI (SA): S.A.S. SNC
 IXY 84094 FUORNI (SA) G.E.S.A.D. SRL DI GESSATO A.
 IXZ 84063 PAESTUM (SA): RANNO FRANCESCO

7. ITALIEN, ITALY, ITALIE, ITALIA, ITALIA,

└

Y

IYA 84030 TRINITA'SALA CONS. (SA): ROSCIANO & C. SNC
IYB 83035 GROTTAMINARDA (AV): TECNODIESEL DI D'AMBROGIO

Z

IZA 70123 BARI (BA): CENTRO TECNICO AUTOELETTRICO
IZB 70126 BARI (BA): MINCUZZI LEONARDO
IZE 81026 RECALE (CE): JANNIELLO MARIO OFF. MECCAN
IZF 70052 BISCEGLIE (BA): PASQUALE LEONARDO
IZG 70054 GIOVINAZZO (BA): DEPALMA SAVINO
IZH 70123 BARI (BA): LORUSSO VITO
IZI 84015 NOCERA SUPERIORE (SA): RONGRI SNC DI RONCA & GRIMAL
IZJ 70026 MODUGNO (BA): EUROMOTOR DI SANTORSOLA
IZN 70017 PUTIGNANO (BA): RICCHI GIUSEPPE
IZO 70124 BARI (BA): MAZZONE ANGELO
IZP 80020 CASAVATORE (NA): ITALKOM
IZR 70022 ALTAMURA (BA): MARVULLI GIUSEPPE
IZS 70051 BARLETTA (BA): LOMUSCIO SAVINO
IZU 70123 BARI (BA): NARDULLI MARIO
IZV 70123 BARI (BA): VALENTINO F. LLI DI VALENTINO
IZW 70030 RUVO DI PUGLIA (BA): MAGGIALETTI ROCCO
IZY 70032 BITONTO (BA): STEA PIETRO
IZZ 70053 CANOSA DI PUGLIA (BA): LISO ANTONIO

7. ITALIEN (2), ITALY (2), ITALIE (2), ITALIA (2), ITALIA (2),

└

A

KAA 72027 SAN PIETRO VERNOTICO: SPEDICATI FRANCESCO
KAB 71100 FOGGIA (FG): DE SARIO NICOLA
KAC 71043 MANFREDONIA (FG): ZERULO ALDO
KAD 71016 SAN SEVERO (FG): MINISCHETTI ANTONIO
KAE 71100 FOGGIA (FG): CASA DELL'AUTORADIO
KAJ 73100 LECCE (LE): MARITATI LUIGI
KAM 70043 MONOPOLI (BA): LENOCI NICOLO
KAP 74100 TARANTO (TA): MAZZEO CARLO
KAT 09170 ORISTANI (OR): PIPPIA GIUSEPPE
KAU 72026 S.PANCRAZIO SALENTINO: ARIANO CARMELO
KAV 74100 TARANTO (TA): PIGNATELLI & BASILE SDF
KAW 75100 MATERA (MT): GRAVINA & DI CARO
KAX 75025 POLICORO (MT): CATALDI MICHELE
KAY 75020 SCANZANO (MT): DE CARO GIUSEPPE & C.
KAZ 75018 STIGLIANO (MT): SARUBBI AUTORICAMBI CALBI A.

B

KBA 85100 POTENZA (PZ): ELETTR. MARINO & CAZZETTA
KBB 85050 VILLA D'AGRI (PZ): ROTUNNO MARIO
KBC 85024 LAVELLO (PZ): CAPRIOLI GENNARO
KBE 85100 POTENZA (PZ): ELETTRODIESEL SNC
KBF 87100 COSENZA (CS): FICCO FRANCO DI G. FICCO
KBG 71042 CERIGNOLA (FG): CASCELLA GIUSEPPE
KBH 87068 ROSSANO SCALO (CS): CIRO' ALDO
KBI 87012 CASTROVILLARI (CS): DI VASTO DOMENICO
KBJ 87065 CORIGLIANO STAZIONE (CS): FALBO ALBERTO
KBK 85029 VENOSA (PZ): M2 DEI F. LLI NATALICCHIO SNC
KBL 70123 BARI (BA): POMPE DIESEL CENTER
KBM 70123 BARI (BA): OFF. RIP. POMPE DIESEL ANCON
KBN 70022 ALTAMURA (BA): DEL VECCHIO MICHELE
KBO 70051 BARLETTA (BA): LA ROTONDA FELICE
KBP 62012 CIVITANOVA MARCHE (MC): EMILI NAZZARENO ELETTRAUTO
KBS 70044 POLIGNANO (BA): TATONE VITO
KBT 70033 CORATO (BA): ROBERTO F. LLI SNC
KBU 71043 MANFREDONIA (FG): RINALDI RAFFAELE
KBV 72100 BRINDISI (BR): LUMINI GABRIELE
KBW 71100 FOGGIA (FG): CENTRO DIESEL
KBX 71100 FOGGIA (FG): FRACASSI & CUSENZA
KBY 71016 SAN SEVERO (FG): TOTARO MARIO
KBZ 73100 LECCE (LE): OFFICINA FOGGIANA DI

C

KCA 74100 TARANTO (TA): CORINI MARIO
KCB 74100 TARANTO (TA): ROMANAZZI PASQUALE DI RAMO A
KCC 74100 TARANTO (TA): C. I. D. DI SARNO EZIO
KCD 74024 MANDURIA (TA): LEONE F. LLI
KCE 75100 MATERA (MT): PIERRO CANIO & MUCCIO
KCF 73100 LECCE (LE): MARITATI MARIO
KCH 87012 CASTROVILLARI (CS): RIPARAUTO

7. ITALIEN (2), ITALY (2), ITALIE (2), ITALIA (2), ITALIA (2),

C

KCI 87070 SIBARI (CS): OFF. SIBARI DI F. LLI CANDIDO
KCJ 87100 COSENZA (CS): TIMFANO DAMIANO
KCK 87100 COSENZA (CS): MUGLIA ANTONIO
KCL 73100 LECCE (LE): QUARTA LUIGI
KCM 87012 CASTROVILLARI (CS): DE TOMMASO GIUSEPPE
KCN 73020 CAVALLINO (LE): SISTEM CAR CENTER
KCO 73048 NARDO' (LE): PALADINI GABRIELE
KCP 70038 TERLIZZI (BA): RUTIGLIANI BIAGIO
KCS 75100 MATERA (MT): PAPA PIETRO DOMENICO
KCT 85100 POTENZA (PZ): GALOTTA CANIO
KCU 87036 RENDE (CS): BOZZARELLO F.
KCV 70027 PALO DEL COLLE (BA): CLEMENTE GIOVANNI
KCX 70123 BARI: MURGOLD FRANCO
KCY 07026 OLBIA (SS): DEIANA PIERO
KCZ 71036 LUCERA (FG): RIPOLI LEONARDO

E

KEA 98100 MESSINA (ME): DILETTI ANTONINO
KEB 98100 MESSINA (ME): GALLETTA GIUSEPPE
KEF 98040 SCALA TORREGROTTA (ME): ESTOLLERE GIUSEPPE
KEG 98100 MESSINA (ME): FRAZZETTO FRANCESCO
KEH 98100 MESSINA (ME): STURNIOLO ANTONIO
KEI 98034 FRANCAVILLA SICILIA (ME): NUZZO FILIPPO
KEJ 93100 CALTANISSETTA (CL): GENTILE F. LLI S.C.
KEK 93012 GELA (CL): ARONICA CALOGERO & C. SA
KEM 88100 CATANZARO (CZ): MERANTE ALFREDO
KEN 88074 CROTONE (CZ): ARILLI ALFONSO
KEO 88068 SOVERATO (CZ): ARCIDIACONO SALVATORE
KEP 88046 LAMEZIA TERME (CZ): TORCASIO ANGELO
KER 89100 REGGIO CALABRIA (RC): CILIONE CONSOLATO
KET 89024 POLISTENA (RC): LUDDENI AURELIO
KEU 98100 MESSINA (ME): GENTILUOMO VINCENZO
KEW 88046 LAMEZIA TERME (CZ): DATTILO & TORCHIA
KEX 98051 BARCELLONA (ME): FRAZZETTO SALVATORE
KEZ 93100 CALTANISSETTA (CL): GIARRATANO GIUSEPPE

F

KFA 93100 CALTANISSETTA (CL): SABELLA SANTO
KFB 93012 GELA (CL): AMARU' GIUSEPPE
KFC 93012 GELA (CL): GALLO BARTOLOMEO
KFD 88063 CATANZARO LIDO (CZ): ROSANO' & DI LUCCA
KFE 61034 FOSSOMBRONE (PS): B.C. SNC DI BALSAMINI & CHIA
KFF 88074 CROTONE (CZ): SCHICCHITANO SALVATORE
KFG 88046 NICASTRO (CZ): GALLINA OSVALDO
KFH 95013 FIUMEFREDDO (CT): INTELISANO MARIO
KFI 89013 GIOIA TAURO (RC): RANIERI ENRICO
KFJ 93012 GELA (CL): SCADUTO PINO ELETTRAUTO
KFK 93013 MAZZARINO (CL): BUCCERI SALVATORE
KFL 88063 CATANZARO LIDO (CZ): LEMME MICHELE

7. ITALIEN (2), ITALY (2), ITALIE (2), ITALIA (2), ITALIA (2),

F

KFM 88019 VIBO MARINA (CZ): PALMIERI GIORGIO
KFN 89013 GIOIA TAURO (RC): STRAPUTICARI DOMENICO
KFO 89044 LOCRI (RC): AUTOSERVICE DI FIATO PIETRO
KFP 70032 BITONTO (BA): ADDUCI CATALDO
KFR 70026 MODUGNO (BA): LOVERGINE & LAVERMICOCCA

G

KGA 95100 CATANIA: RE. VI SRL
KGC 95024 ACIREALE (CT): LEONARDI & SEMINARA
KGE 96100 SIRACUSA (SR): GIUFFRIDA ROSARIO
KGF 70100 BARI: BLASI GIOVANNI
KGG 09131 CAGLIARI: EUROTCH MOTORS DI SCALA
KGH 95122 CATANIA (CT): MESSINA SALVATORE
KGI 95026 ACITREZZA (CT): BONANNO MARIO
KGJ 94100 ENNA: MINGRINO LIBORIO
KGM 97100 RAGUSA (RG): TUMINO ROSARIO
KGN 97015 MARINA DI RAGUSA (RG): GUERRIERI NUNZIO
KGP 95024 ACIREALE (CT): ELETTO-DIESEL CENTER
KGR 96100 SIRACUSA (SR): CIRINNA' MATEO
KGT 96011 AUGUSTA (SR): SARACENO SEBASTIANO
KGU 96011 AUGUSTA (SR): GIANINO GIUSEPPE
KGW 95130 CATANIA (CT): FERLITO GIUSEPPE
KGY 95121 CATANIA (CT): DALA DI GIUFFRIDA-GULLOTTA
KGZ 95131 CATANIA (CT): SICIL DIESEL DI SCIACCA

H

KHA 97100 RAGUSA (RG): CASONE EMANUELE
KHB 95020 ACI BONACCORSI (CT): BASILE GIUSEPPE
KHC 09017 SANT'ANTIOCO (CA): PUDDU LUCIANO
KHD 96100 SIRACUSA (SR): BRONZI & ANDRONICO
KHE 09027 SERRENTI (CA): PALMAS LUIGI OFF. DIESEL
KHF 96012 AVOLA (SR): TARASCIO F. LLI
KHG 97015 MODICA (RG): RAIAD DI ROCCASALVA & BOSCAR
KHH 89029 TAURIANOVA (RC): SCIONTI ROCCO JUNIOR
KHI 95040 BELPASSO (CT): CONSOLI VITO
KHK 95047 PARTERNO' (CT): TECNO DIESEL
KHM 95030 TREMESTIERI ETNEO (CT): MAUGIERI F. LLI
KHN 95049 VIZZINI (CT): GIARRUSSO GAETANO
KHO 97100 RAGUSA (RG): CARPENZANO & BOSCARINO
KHR 97013 COMISO (RG): BARBAGALLO GIUSEPPE
KHT 97018 SCICLI (RG): BOSCARINO ALDO
KHV 88018 VIBO VALENTIA (CZ): IELO UGO
KHX 96010 PRIOLO (SR): GERRATANA SALVATORE
KHY 96019 ROSOLINI (SR): CELESTE CARMELO
KHZ 94100 ENNA: FALZONE VINCENZO

I

KIA 90141 PALERMO (PA): VELLA GIUSEPPE
 KIB 95131 CATANIA: COSTANZO GIUSEPPE
 KIC 90145 PALERMO (PA): ARMETTA ANTONINO
 KID 90146 PALERMO (PA): SALERNO GIACOMO
 KIE 90133 PALERMO (PA): R.A.D.A.R. SRL
 KIF 90025 LERCARA FRIDDI (PA): NOTO FRANCESCO
 KIH 90127 PALERMO (PA): LA PIANA SALVATORE
 KII 90141 PALERMO (PA): AMMIRATA AUTONIO
 KIJ 90027 PETRALIA SOTTANA (PA): DI VINA & VENUTA
 KIK 90138 PALERMO (PA): SAVARINO VINCENZO
 KIL 90125 PALERMO (PA): MARTINO IGNAZIO
 KIM 94015 PIAZZA ARMERINA (EN): DI DID CAMERINO AMERIGO
 KIN 96011 AUGUSTA (SI): MESSINA GIUSEPPE
 KIO 90146 PALERMO (PA): CUSUMANO SALVATORE
 KIP 90044 CARINI (PA): ARA DI PASSALACQUA S
 KIR 90079 TERRASINI (PA): CATANESE ANTONINO
 KIS 90145 PALERMO (PA): PRESTIGIACOMO VINCENZO
 KIV 92100 AGRIGENTO (AG): CUCCHIARA GIUSEPPE
 KIW 92020 RECALMUTO (AG): FANTAUZZO GIUSEPPE
 KIX 92026 FAVARA (AG): BELLOMO ANTONIO
 KIZ 92016 RIBERA (AG): LIOTTA ANTONINO

J

KJA 92021 ARAGONA (AG): MORREALE FILIPPO
 KJB 92024 CANICATTI (AG): MULONE VINCENZO
 KJC 92025 CASTELTERMINI (AG): ROTOLO DOMENICO
 KJE 92013 MENFI (AG): D'ANGELO VITO
 KJG 91025 MARSALA (TP): BONAFEDE GIUSEPPE
 KJI 91027 PACECO (TP): MARTINICO ANTONINO
 KJK 91022 CASTELVETRANO (TP): PISCIOTTA GIOVANNI
 KJL 92016 RIBERA (AG): CARUSO SANTO
 KJM 90143 PALERMO: RIPARAUTO SNC DI AMOROSO
 KJN 97015 MODICA (RG): C.E.I.B. DI BOCCADIFUOCO
 KJO 91100 TRAPANI (TP): GUCCIARDI LUIGI
 KJP 90139 PALERMO (PA): BONDI FRANCESCO
 KJR 90124 PALERMO (PA): GUARDI' F. LLI
 KJS 90135 PALERMO (PA): O.R.P.I. DI VITALE A.
 KJT 92100 AGRIGENTO (AG): SICIL DIESEL DI SARDISCO G.
 KJU 92019 SCIACCA (AG): TACCI VINCENZO
 KJV 92027 LICATA (AG): BERRITELLA FRANCESCO
 KJW 91100 TRAPANI (TP): DAIDONE & LOMBARDO
 KJX 91026 MAZARA VALLO (TP): NORRITO GIUSEPPE
 KJY 91100 TRAPANI (TP): CRACCHIOLO & DOMINDO
 KJZ 91011 ALCAMO (TP): GIORDANO & FERRARO SDF

K

KKA 91022 CASTELVETRANO (TP): FUGLISI GAETANO
 KKC 91025 MARSALA (TP): CANNAVO' GIUSEPPE
 KKD 91025 MARSALA (TP): GIORLANDO STEFANO
 KKE 07100 MARSALA: PACCIONI BRUNO
 KKF 92100 AGRIGENTO (AG): NOVA DIESEL DI PROIETTO M.
 KKG 92022 CAMMARATA (AG): CAIRONE N. & MAGGIO D. SNC
 KKH 90141 PALERMO (PA): FASITTA GAETANO
 KKI 90011 BAGHERIA (PA): LBC ELECTRONICS SNC DI LO BU
 KKJ 90046 MONREALE (PA): GANCI MARIO
 KKK 09121 CAGLIARI: VICTORS MOTORS

L

KLA 09100 CAGLIARI (CA): DETTORI DAMIANO & RAFFAELE
 KLB 09045 QUARTU SANT'ELENA (CA): NOSSARDI FABIO
 KLC 09013 CARBONIA (CA): MARROCU NORBERTO
 KLD 09036 GUSPINI (CA): SERPI CESARE
 KLE 09100 FIRRRI (CA): NOSSARDI WALTER
 KLF 09045 QUARTU SANT'ELENA (CA): DEIANA & RUGGERI
 KLG 09037 SAN GAVINO MONREALE: GAGLIARDINI SESTO
 KLI 08100 NUORO (NU): FLORE ACHILLE
 KLJ 08015 MACOMER (NU): ANGIOI FIERO
 KLK 08048 TORTOLI (NU): SUELLA GIOVANNI
 KLL 09074 GHILARZA (OR): FORCU GIOVANNI
 KLM 09013 CARBONIA (CA): DI BIASE CARMINE
 KLN 07100 SASSARI (SS): CORVEDDU ELETTROFFICINA
 KLO 07100 SASSARI (SS): SECHI MARIO
 KLP 09100 CAGLIARI (CA): PALA GIUSEPPE
 KLR 07100 SASSARI (SS): MANCONI PIER LUIGI
 KLS 07026 OLBIA (SS): DALIAS & DEIANA SNC
 KLT 07037 SORSO (SS): CAMPUS SALVATORE
 KLU 07014 OZIERI (SS): MEZZANO MARIO
 KLV 09100 CAGLIARI (CA): AMBU F. LLI & MEDDA
 KLW 09100 CAGLIARI (CA): ZANDA GIOVANNI
 KLX 08100 NUORO (NU): OFF. RIUNITE B.B.C. SRL
 KLY 09044 QUARTUCCIU (CA): GUAIME ALDO OFF. ELETTRAUTO
 KLZ 08048 TORTOLI (NU): MEREU ATTILIO

M

KMA 07100 SASSARI (SS): MELONI ALFREDO
 KMB 07100 SASSARI (SS): CANU SALVATORE
 KMD 07026 OLBIA (SS): ATZORI MICHELE
 KME 09122 CAGLIARI: ASUNIS ERMINIO
 KMF 09096 SANTA GIUSTA (OR): CAMEDDA BENITO & VITTORIO
 KMG 08100 NUORO (NU): MELONI A. & G. SDF
 KMH 07014 OZIERI (SS): FANTASIA MATTEO
 KMI 07046 PORTO TORRES (SS): GASPA GAVINO

7. ÖSTERREICH, AUSTRIA, AUTRICHE, AUSTRIA, AUSTRIA,

1

A

OAJ WIEN 23: FIRMA PESTUKA
OAP ASCHBACH: FIRMA FEHBÖCK

B

OB3 BADEN: FIRMA BARBACH
OBF BREGENZ: FIRMA FERCHER
OBW BLUDENZ: FIRMA WALCH
OBZ BAD ISCHL: FIRMA ZEWAG GMBH

D

ODH DEUTSCH-GORITZ: FIRMA HIRSCHMUGL
ODP DELLACH: FIRMA PIBER

E

OES EFERDING: FIRMA J. STECKBAUER

F

OFU FELDBACH: SÜED-OST REIFEN UND SERVICE GES.M.B.H.

G

OGG GROSS-ENZERSDORF: FIRMA GAUGITSCH

H

OHG HEILIGENBLUT: FIRMA JOSEF LACKNER
OHH HERZOGENBURG: FIRMA KNABB

I

OIN INNSBRUCK: FIRMA WALDNER

K

OKI KITZBÜHEL: FIRMA STANGER
OKM KLAGENFURT: FIRMA MÜNCH
OKP KNITTELFELD: FIRMA PLATTNER
OKU KUFSTEIN: FIRMA ASCHENBRENNER

7. ÖSTERREICH, AUSTRIA, AUTRICHE, AUSTRIA, AUSTRIA,

1

L

OLG LIENZ: FIRMA GASSER
OLS LINZ: FIRMA WERNER STRASSER, KFZ-ELEKTRO UND MECHANIK

M

OMF MOEDLING: FIRMA GERHARD SCHOBERT

N

ONE NEUNKIRCHEN: FIRMA AUER
ONS NEUTILLMITSCH: FIRMA SACKL

P

OPF PETZENKIRCHEN: FIRMA SCHAFF

R

ORO ROHRBACH: FIRMA OBERAIGNER

S

OSG SCHRUNS: FIRMA GANAHL
OSK STRASSWALCHEN: FIRMA KORNFROBST
OSM HOLLABRUNN: FIRMA MARZY
OSO SCHÄRDING: FIRMA DOPPLER

T

OTM TAMSWEG: FIRMA MOSER

V

OVH VÖLKERMARKE: FIRMA HOFSTÄTTER
OVO VÖCKLABRUCK: FIRMA OBERNDORFER

W

OWB WIEN 15: FIRMA BRUCKBERGER
OWE WIEN 21: FIRMA REICHL
OWG WIEN 15: FIRMA GINNER
OWK WILDON: FIRMA AUTOELEKTRIK & KFZ-MECHANIK
OWR WALS: FIRMA REISCHL

6. SAMBIA, ZAMBIA, ZAMBIE, ZAMBIA, ZAMBIA,

┌

I

SIA KITWE: DIESEL ELEKTRIK LTD.

K

SKA LUSAKA: DIESEL ELEKTRIK LTD.

6. SAUDI-ARABIEN, SAUDI-ARABIA, ARBIE-SAUDITE, ARABIA-SAUDITA, ARABIA-SAUDITA,

└

A

AAD DAMMAM: DIESEL ELECTRIC CO.
AAJ JEDDAH: DIESEL ELECTRIC CO.
AAR RIYADH: DIESEL ELECTRIC CO.

6. IRAK, IRAQ, IRAQ, IRAQ, IRAQ,

└

A

IAE BAGHDAD: AUTOMOBILE STATE ENTERPRISE

6. KUWAIT, KUWAIT, KUWAIT, KUWAIT, KUWAIT,

└

K

KKM KUWAIT ARABIAN GULF: ABDULAZIZ ALI MUTAWA

6. OMAN, OMAN, OMAN, OMAN, OMAN,

└

R

ORM RUWI:MALATAN

6. SINGAPUR, SINGAPORE, SINGAPOUR, SINGAPUR, SINGAPORE,
MALAYSIA , MALAYSIA , MALAYSIA , MALASIA, MALAYSIA

A
XAD 91000 TAWAU EAST MALAYSIA APAS DIESEL FUEL INJECTION PART CO

B
XBD 97008 BINTULU EAST-MALAYSIA BINTULU DIESEL SDN BHD

C
XCD 85000 SEGAMAT WEST-MALAYSIA CENTRAL DIESEL FUEL INJECTION PUMP SERV.

D
XDI 88807 KOTA KINABALU EAST-MALAYSIA DIESEL INJECTION & ENGINEERING (SABAH)

H
XHL 86000 KLUANG WEST-MALAYSIA HENG LEE FUEL PUMP SERVICE SDN BHD
XHS 80200 JOHOR BAHRU WEST-MALAYSIA HUP SENG FUEL INJECTION PUMP SERVICE

K
XKD 25300 KUANTAN WEST-MALAYSIA KUANTAN DIESEL FUEL PUMP SDN BHD
XKF 15050 KOTA BAHRU WEST-MALAYSIA KELANTAN FUEL PUMP SERVICE
XKS 98000 MIRI EAST-MALAYSIA KEYSER SDN BHD

P
XPD 90300 SANDAKAN EAST-MALAYSIA PERKHIDMATAN DIESEL SABAH

S
XSB SINGAPORE: ROBERT BOSCH PTE. LTD.
XSF 96008 SIBU EAST-MALAYSIA SIBU FUEL INJECTION PUMP SERVICE SDN BHD
XSL 2367 SINGAPORE SINGAPORE SEA LAND DIESEL SPARES & SERVICE PTE LTD

T
XTD 21000 KUALA TRENGGANU WEST-MALAYSIA TRENGGANU DIESEL FUEL PUMP SERVICE
XTF 12200 BUTTERWORTH WEST-MALAYSIA TEIK FUEL INJECTION PUMPS SERVICE
XTH 75250 MELAKA WEST-MALAYSIA TAN HUP SENG FUEL PUMP COMPANY SDN BHD

6. SINGAPUR, SINGAPORE, SINGAPOUR, SINGAPUR, SINGAPORE,
MALAYSIA , MALAYSIA , MALAYSIA , MALASIA, MALAYSIA

U
XUF 5150 ALOR SETAR WEST-MALAYSIA UNITED FUEL INJECTION PUMP SERVICE

W
XWS 2057 SINGAPORE SINGAPORE WING SING FUEL INJECTION PUMP SERVICE

Y
XYS 30250 IPOH WEST-MALAYSIA YAU SENG FUEL PUMP SERVICES SDN BHD

6. KOREA, COREA, COREA, COREA, COREA,



S

YSB SEOUL: BOSCH KOREA LTD.
YSY SEOUL: YANG YANG TRADING LTD.

6. SUEDAMERIKA, SOUTH AMERICA, AMERIQUE DU SUD, AMERICA DEL SUR, xxxxx,

T

S

BSC SANTA CRUZ: ELEKTRO DIESEL V.C.

6. SUEDAMERIKA, SOUTH AMERICA, AMERIQUE DU SUD, AMERICA DEL SUR, xxxxx,

T

F

MFC MARTINIQUE/FORT-DE-FRANCE: ETS. CENTRAL DIESEL

- A 01 Werkstatt-Kennzeichen für instandgesetzte, überprüfte, überholte und geänderte Erzeugnisse
- A 05 WORKSHOP DESIGNATIONS FOR REPAIRED, CHECKED, SUPERSEDED AND MODIFIED PRODUCTS.
- A 09 MARQUAGES D'IDENTIFICATION DES ATELIERS SUR LES PRODUITS REMIS EN ETAT, CONTROLES, REVISES ET MODIFIES.
- A 13 SIMBOLOS DE TALLER PARA PRODUCTOS REPARADOS, VERIFICADOS, REPASADOS Y MODIFICADOS.
- A 17 CONTRASSEGNI DI OFFICINA PER PRODOTTI RIPARATI, VERIFICATI, REVISIONATI E MODIFICATI.

AA- BY	BUNDESREPUBLIK DEUTSCHLAND FED. REP. OF GE RMANY REP. FED. D ALL	B 01
CB- EJ		B 02
EK- GU		B 03
GW- IT		B 04
JA- LO		B 05
LP- NP		B 06
NR- PX		B 07
RA- SZ		B 08
TA- WE		B 09
WF- YM		B 10
YN- ZZ		B 11

L B R D

KOORDINATE

AA-- CS	BUNDESREPUBLIK DEUTSCHLAND FED. REP. OF GE RMAN Y REP. FED. D ALL	C 01
DB- GL		C 02
GM- KM		C 03
KO- MW		C 04
NE- RW		C 05
RX- UZ		C 06
VA- ZX		C 07

1
B R D

=====

KOORDINATE

=====

AA- DV BUNDESREPUBLIK DEUTSCHLAND FED. REP. OF GE RMANY REP. FED. D ALL
EA- HH
HI- LW
MB- RX
SA- WU
WV- ZZ

D 01
D 02
D 03
D 04
D 05
D 06

Europa, Europe

KOORDINATE

BAB-BGA	BELGIEN BELGIUM BELGIQUE BELGICA BELGIO	E 01
BHO-BFY		E 02
BRE-BZI		E 03
CAD-CEM	SCHWEIZ SWITZERLAND SUISSE SUIZA SVIZZERA	E 04
CFH-CMZ		E 05
CNK-CUW		E 06
CVH-CZT		E 07
DAB-DBY	DANEMARK DENMARK DANEMARK DINAMARCA DANIMARCA	E 08
DCA-DCC		E 09
EAB-EBT	SPANIEN SPAIN ESPAGNE ESPANA SPAGNA	E 10
ECA-EDY		E 11
EDZ-EFT		E 12
EFU-EHN		E 13
EHO-EJI		E 14
EJJ-EKZ		E 15
ELA-EMY		E 16
EMZ-EOT		E 17
EQU-ERN		E 18
ERO-ETI		E 19
ETJ-EWM		E 20
EWN-EZJ		E 21
EZK-EZZ		E 22
GAA-GDI	GROSSBRITANNIEN GREAT BRITAIN GRANDE-BRETAGNE GRAN BRETAGNA GRAN BRETAGNA	E 23
GDJ-GGW		E 24
GGX-GJY		E 25
GKB-GMJ		E 26
GMK-GOP		E 27
GOR-GRO		E 28
GRP-GTY		F 01
GTZ-		F 02

Europa, Europe

KOORDINATE

HAA-HBZ	NIEDERLANDE NETHERLANDS LES PAYS-BAS FAISES BAJOS PAESI BASSI	F 03
HCD-HWR		F 04
IAA-IBZ	ITALIEN ITALY ITALIE ITALIA ITALIA	F 05
ICA-IDZ		F 06
IEA-IGZ		F 07
IHB-IJU		F 08
IJV-IMU		F 09
IMV-IOS		F 10
IOT-IRZ		F 11
ISA-IUZ		F 12
IVA-IXG		F 13
IXI-IZI		F 14
IZJ-IZR		F 15
KAA-KBZ	ITALIEN (2) ITALY (2) ITALIE (2) ITALIA (2) ITALIA (2)	F 16
KCA-KDZ		F 17
KED-KGL		F 18
KHA-KKM		F 19
KKR-KMZ		F 20
KNA-KOZ		F 21
KPA-KSL		F 22
KSM-KUE		F 23
KWA-KYM		F 24
KYN-KZZ		F 25
LAS-LKD	FINNLAND FINLAND FINLANDE FINLANDIA FINLANDIA	F 26
LKE-LOS		F 27
LPD-LVU		F 28
LYS-		G 01
NAA-NCY	NORWEGEN NORWAY NORVEGE NORUEGA NORVEGIA	G 02
NDB-NDW		G 03

 Europa, Europe

KOORDINATE

OAM-ONW	ÖSTERREICH AUSTRIA AUTRICHE AUSTRIA AUSTRIA	G 04
ORE-OWZ		G 05
PTM-	POLEN POLAND POLOGNE POLONIA POLONIA	G 06
SAA-SCH	SCHWEDEN SWEDEN SUEDE SUECIA SVEZIA	G 07
SCJ-SEH		G 08
SEI-SEV		G 09
TAA-TBZ	TÜRKEI TURKEY TURQUIE TURQUIA TURCHIA	G 10
TCA-TDZ		G 11
TEA-TFF		G 12
UAA-UBY	SPANIEN SPAIN ESPAGNE ESPANA SPAGNA	G 13
UBZ-UDT		G 14
UDU-UEF		G 15



Europa, Europe

KOORDINATE

101-157	FRANKREICH FRANCE FRANCE FRANZIA FRANZIA	G 16
160-199		G 17
203-259	FRANKREICH FRANCE FRANCE FRANZIA FRANZIA	G 18
260-295		G 19
306-358	FRANKREICH FRANCE FRANCE FRANZIA FRANZIA	G 20
360-397		G 21
400-458	FRANKREICH FRANCE FRANCE FRANZIA FRANZIA	G 22
462-498		G 23
501-566	FRANKREICH FRANCE FRANCE FRANZIA FRANZIA	G 24
571-597		G 25
601-659	FRANKREICH FRANCE FRANCE FRANZIA FRANZIA	G 26
660-699		G 27
700-738	FRANKREICH FRANCE FRANCE FRANZIA FRANZIA	G 28
740-779		H 01
780-792		H 02
854-	FRANKREICH FRANCE FRANCE FRANZIA FRANZIA	H 03
901-953	FRANKREICH FRANCE FRANCE FRANZIA FRANZIA	H 04

Europa, Europe

KOORDINATE

IAF-IDY	ITALIEN ITALY ITALIE ITALIA ITALIA	I 01
IEA-IGN		I 02
IIA-IKM		I 03
IKN-IMO		I 04
IMS-IOP		I 05
IOR-ISU		I 06
ISV-IVZ		I 07
IWA-IXZ		I 08
IYA-IZZ		I 09
KAA-KCH	ITALIEN (2) ITALY (2) ITALIE (2) ITALIA (2) ITALIA (2)	I 10
KCI-KFL		I 11
KFM-KHZ		I 12
KIA-KJZ		I 13
KKA-KMI		I 14
OAJ-OKU	ÖSTERREICH AUSTRIA AUTRICHE AUSTRIA AUSTRIA	I 15
OLG-OWR		I 16

SIA-SKA

SAMBIA ZAMBIA ZAMBIE ZAMBIA ZAMBIA

J 01



Asien/Australien

KOORDINATE

AAD-AAR	SAUDI-ARABIEN SAUDI-ARABIA ARBIE-SAOUDITE ARABIA-SAUDITA ARABIA-SAUDITA	K 01
IAE-	IRAK IRAQ IRAQ IRAQ IRAQ	K 02
KKM-	KUWAIT KUWAIT KUWAIT KUWAIT KUWAIT	K 03
ORM-	OMAN OMAN OMAN OMAN OMAN	K 04
XAD-XTH	SINGAPUR SINGAPORE SINGAPOUR SINGAPUR SINGAPORE	K 05
XUF-XYS		K 06
YSB-YSY	KOREA COREA COREA COREA COREA	K 07

BSC- SUEDAMERIKA SOUTH AMERICA AMERIQUE DU SUD AMERICA DEL SUR xxxxx

L 01

MFC- SUEDAMERIKA SOUTH AMERICA AMERIQUE DU SUD AMERICA DEL SUR xxxxx

L 02